



# Right Angle Transfer Module F-RAT-NX75

Flat-Right Angle Transfer

## < User Manual >



**Read this manual before use**

Thank you for purchasing the Right Angle Transfer Module (hereinafter referred to as "this product").

### About the Models described in This User Manual

- In this User Manual, both the standard type and the E1 type are described.
- E1 type is a model to be selected when operating conditions require a size of 7580, 9070, or 9080, and the environmental temperature is 10°C or below, with a transfer speed of 45m/min or faster.
- E1 type differs from the standard type in terms of the mechanical structure, standard drivers, and wiring that need to be prepared.
- Unless otherwise specified in this User Manual, the common information for both standard type and E1 type are described. If necessary, details for the standard type and the E1 type are written separately.

**Standard type**  : Described for Standard type

**E1 type**  : Described for E1 type



Make sure to read this manual carefully before using, and start using only after you have understood all the product's functions, safety information and precautions.

After reading the manual, make sure to keep it safe in a specified place for future use, whenever necessary.

## 1. Introduction

### Features

#### Features of this product

- This product is a module to divert at a right angle without changing its level, and there is no impact on the trays.
- All-electric control. No pneumatics, which do not require compressor.

### Operation description (when diverting at a right angle)

Load

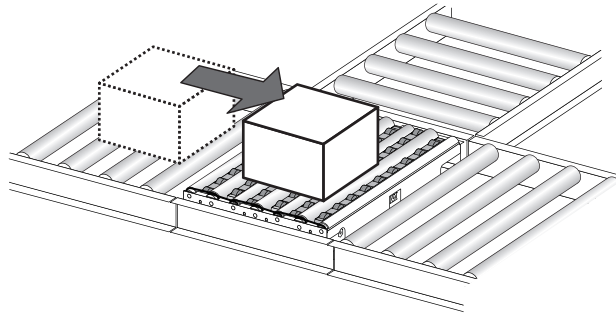

Switch to the diverting  
direction

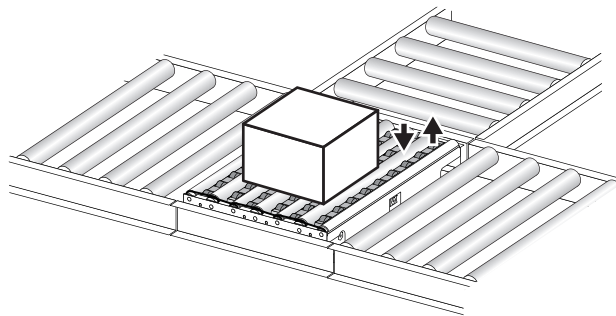

Discharge

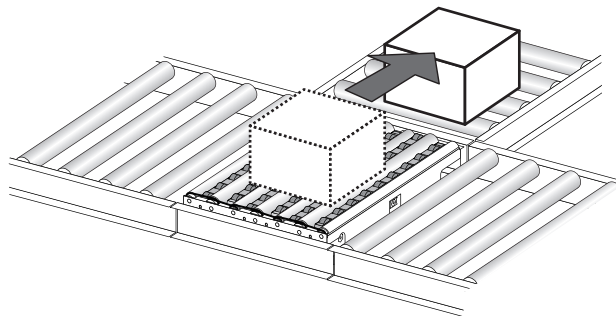

Switch to the straight  
direction

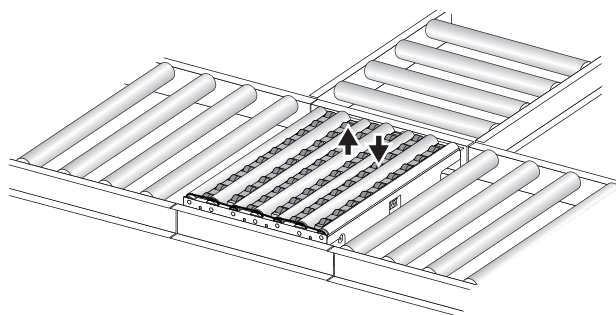

## 1. Introduction

### Disclaimer

- This product is designed as a general industrial device. Do not use for other applications. We do not take any responsibility for any damage that may result from the disregarding of these warnings.
- In the event that an accident results from the use of this product, we do not compensate for any damage, including abnormalities of equipment, connection devices, and/or software, any damage resulting from malfunctions, and/or any other secondary damage.
- Caution : Installation, operation and usage of ITOH DENKI MDRs in combination with a control card designed by a third party could result in fatal phenomena such as fire, electric shock, injuries etc which are out of the responsibility of ITOH DENKI.

### Notes on industrial property rights

There are some examples of parts that need to be prepared by customers, as explained within this manual. However, this does not provide any guarantee against the existence of any rights, such as our industrial property rights, or those of other companies.

### Notes on technical support

We respond to technical inquiries based on the contents described within this manual, and on this product within the range of general items for this product unit. There are some descriptions in this manual, about parts, equipment, and wiring arranged by customers, as well as the controls and operation under such circumstances. However, these are not included in the guaranteed operating range and/or support. When in use, please check and perform the aforementioned based on your responsibility according to operation.

### About the performance level (PL) for this system

This product is based on the performance level "C"<sup>\*2</sup> in ISO-13849-1<sup>\*1</sup>.

- \* 1 : International Organization for Standardization
- \* 2 : This indicates that even though events that would result in serious injury occur infrequently under assumed risk environment, there is a high probability to avoid danger if you observe the safety contents described in this manual.

### About installation environment

This product is not equipped with special dust proof/waterproof countermeasures, and is intended to be used in environments of "Pollution Degree 2"<sup>\*2</sup>, as defined in IEC60664 -1<sup>\*1</sup>.

- \* 1 : Insulation coordination for equipment within low-voltage supply systems - Part 1 of the International Standard
- \* 2 : Non-conductive pollution will occur, but it is assumed that condensation will happen to generate conductive property temporarily.

### About description of the product

- Depending on the signal type (NPN/PNP) specified by customers, different models of control driver cards are supplied as being the standard for this product.
- Accompanied driver is described in table below. Input signal type as NPN or PNP is clearly described if necessary.

Included driver card model		Described in this User Manual
NPN	PNP	
CBK-109FN	CBK-109FP	CBK-109
HBK-608FN-CP3	HBK-608FP-CP3	HBK-608-CP3
CB-016BN6	CB-016BP6	CB-016
HBM-201BN	HBM-201BP	HBM-201

**2. Procedures from installation to operation**

Procedures from installation to operation

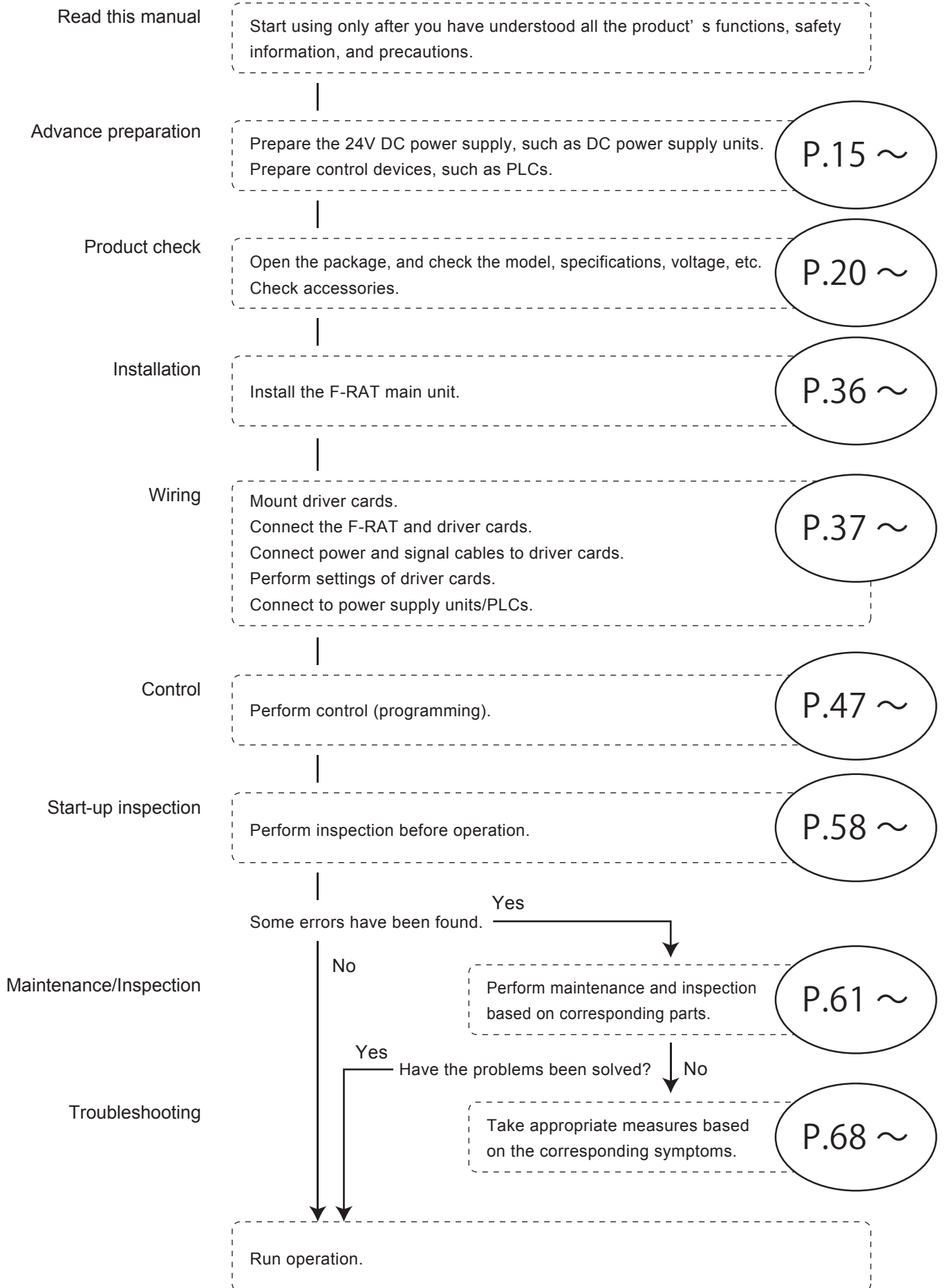

## 2. Procedures from installation to operation

### INDEX

1. Introduction	.....	2
2. Procedures from installation to operation	.....	4
3. Safety precautions	.....	6
3-1. General precautions	.....	8
3-2. Precautions on installation	.....	10
3-3. Precautions on wiring	.....	11
3-4. Precautions related to control	.....	11
3-5. Precautions related to operation	.....	12
3-6. Precautions on maintenance and inspection	.....	12
4. Advance preparation	.....	14
5. Product check	.....	19
6. Structures	.....	23
7. Installation/Wiring	.....	25
7-1. Before installation	.....	26
7-2. Installation	.....	36
7-3. Wiring	.....	38
8. Control/Operation	.....	45
8-1. Basic operation	.....	47
8-2. Switching the transfer direction	.....	50
8-3. Changing the speed	.....	51
8-4. Switching the transfer surface	.....	55
8-5. About the initial position setting (teaching) of the transfer surface	.....	56
8-6. Program example	.....	57
8-7. What to do before operation	.....	58
9. Maintenance/Inspection	.....	60
9-1. Driver card LED display and error countermeasures	.....	61
9-2. Before replacement work	.....	66
9-3. Replacement of MDR for roller transfer/idlers/roller drive belts	.....	68
9-4. Replacement of the carrier wheel cassette	.....	73
10. Troubleshooting	.....	75
Appendix	.....	79
Appendix 1. Product specifications	.....	80
Appendix 2. Replacement parts/Options	.....	83
Appendix 3. Residual risk list/MAP	.....	84

# 3. Safety precautions

For parts names in sentences, refer to 6. Structures (P.21).



3-1. General precautions	.....	8
3-2. Precautions on installation	.....	10
3-3. Precautions on wiring	.....	11
3-4. Precautions related to control	.....	11
3-5. Precautions related to operation	.....	12
3-6. Precautions on maintenance and inspection	.....	12

### 3. Safety precautions

#### Danger level



To prevent hazards to users and/or others, and/or damage to property in advance, the important precautions to be followed securely is described below.

- The degree of hazard and/or damage that may result if a user disregards the description and operates the product improperly is categorized as the following symbols and explained below.

 <b>WARNING</b>	This indicates a high possibility that severe injury or even death may result.
 <b>CAUTION</b>	This indicates a high possibility that injury, or only property damage may result.

#### Symbol explanation

- The type of precautions is categorized as the following symbols and explained below.

	This symbol indicates a reminder which users should pay attention to.
	This symbol indicates operations that are prohibited.
	This symbol indicates forced operations that users should always perform.

### 3. Safety precautions

#### 3-1.

#### General precautions

### WARNING



Do not use the product near places subject to explosive, flammable gas, and/or corrosive atmosphere, and/or combustible materials.

Failure to follow this could result in explosion, fire, electric shock and/or injury.



When using the product in places where serious accidents and/or damage may possibly occur, install backup and/or fail-safe functions systematically.

Failure to follow this could result in the inability to control this product due to driver card malfunction, which could lead to serious accidents.

### CAUTION



Do not apply heavy loads to this product, such as stepping on it.

Failure to follow this could result in people falling and/or malfunction.



Do not come into contact with the moving parts, such as the carrier wheels, rollers, or lifting sections, and/or allow clothes to get close to them.

Failure to follow this could result in them getting caught and/or stuck.



Do not forcibly bend and/or pull cables.

Also, do not put heavy materials on cables, or do not get them stuck between cables.

Failure to follow this could result in fire and/or electric shock due to cable damage.



Never remodel the product and/or driver cards.

Failure to follow this could result in serious accidents.



Make sure to attach ground wires to this product and the DC power supply unit.

Failure to follow this could result in electric shock if any malfunction or leakage occurs.



Do not touch the product when it has just stopped operation.

Failure to follow this could result in burns.



Do not put water and/or oil on the product, and do not transfer wet and/or oily trays.

Failure to follow this could result in electric shock, and/or malfunction.



Do not apply strong impact and/or excessive force to the product, such as hitting it with objects, or dropping it. Also, do not use the equipment if strong impact has been applied, and/or if the appearance has become deformed.

Failure to follow this could result in malfunction due to applied impact.

### 3. Safety precautions

#### 3-1. General precautions

#### CAUTION



**Stop operation when abnormal sound is heard during operation.**

Failure to follow this could result in unexpected accidents.



**Do not use in a way exceeding the range of the product specifications.**

Failure to follow this could result in malfunction, fire, and/or injury.



**Turn off the power supply to the product before moving and/or installing the product, and performing maintenance and inspection (excluding those during operation).**

Working while the power is on could result in accidents due to unexpected operation.



**Observe the safety regulations required for installation locations, and/or products in use.**



**Securely wire each cable to connection parts.**

Improper wiring could result in electric shock and/or malfunction.



**Do not turn on/off relays and/or contactors near power cables, signal cables, and/or driver cards.**

Failure to follow this could result in malfunction due to noise generation.



**LED or Pull-up/Pull-down circuits implemented in the output circuit of control devices could result in unexpected operation.**

Carefully check the output circuit.



**Turn on the power in order of external control devices, and then the product.**

**Turn off the power in order of the product, and then external control devices.**

Turning on/off the power in the wrong order could result in malfunction.



**Do not unplug power and/or signal cables during operation. Also, do not run/stop this product by the power supply. (Use the signal.)**

Failure to follow this could result in malfunction.



**Do not forcibly rotate the MDR at times other than maintenance and inspection.**

Failure to follow this could result in damage to driver cards, and/or their lifetime to be significantly shortened.



**Do not turn off the power during transfer (during MDR rotation).**

Failure to follow this could result in malfunction.

**3. Safety precautions**

**3-1. General precautions**

 **CAUTION**



**Do not turn on the power when trays are unstable.**  
Failure to follow this could result in injury, accidents, and/or damage due to load collapse.



**Make sure to perform the start-up inspection, and check that devices are free from any abnormalities, and that safety equipment functions correctly before using the product.**



**When disposing of the product, make consigning contracts with licensed industrial waste disposers, and consign the disposal to them.**

**3-2. Precautions on installation**

 **WARNING**



**In principle, have two or more persons work when carrying and/or installing the product as it is a heavy load.**

**When hoisting this product, never enter the area under the suspended load.**



When hoisting, use appropriate hoisting equipment, and pay special attention to prevent the balance of the suspended load from being lost and/or falling. Also, have only qualified workers conduct the operation. Improper hoisting could result in serious accidents.



**Do not hoist this product with goods loaded.**  
Failure to follow this could result in objects falling.

 **CAUTION**



**When handling, wear protective equipment, such as gloves.**  
Since this product consists in large part of metal, careless handling could result in hands getting injured.



**Make sure to use the recommended tightening torque to tighten bolts for installing the F-RAT main unit and/or fastening screws of driver cards.**  
Failure to follow this could result in bolts and/or screws loosening, and/or malfunction.



**Check the corresponding installing direction to the loading/discharging sides before installing.**  
Failure to follow this could result in objects/body parts getting caught and/or stuck.

### 3. Safety precautions

#### 3-2.

#### Precautions on installation

### CAUTION



Take appropriate measures to prevent trays from popping out of the equipment.

For example, mount guide rails on the conveyor frames.  
Failure to follow this could result in workers getting injured by trays popping out of the equipment.



If necessary warning/caution labels become hidden after installing fences, affix again on places where they can be seen.

#### 3-3.

#### Precautions on wiring

### CAUTION



Perform wiring when the power is shut off.

Failure to follow this could result in electric shock and/or accidents due to unexpected operation.



When attaching or removing connectors, turn off the power first, securely hold connectors, and perform operation.

Also, do not apply excessive force to the driver card connection parts, such as obliquely attaching or removing connectors.

Failure to follow this could result in electric shock, malfunction, and/or accidents due to unexpected operation.



Securely attach connectors to the driver card connection parts.

Improper wiring could result in electric shock and/or malfunction.



Perform wiring to connectors so that cables make secure contact with connectors.

Barb lines from the cable core could result in heat generation and/or fire due to changes of contact resistance, and/or short circuit with the adjacent contact.

#### 3-4.

#### Precautions related to control

### CAUTION



Do not change switch settings for HBM-201.

Failure to follow this could result in malfunction, and/or accidents due to unexpected operation.



Do not change the VR1 and VR2 values on CBK-109 and CB-016.  
(Minimum (leftmost): Factory setting)



Do not turn the driver card switches with excessive force.

Failure to follow this could result in malfunction.

### 3. Safety precautions

#### 3-5.

#### Precautions related to operation

### CAUTION



**Do not forcibly move trays when they are placed on the carrier wheels.**

Failure to follow this could result in damage and/or malfunction.



**Make sure to perform the start-up inspection before starting operation.**



**At the start-up inspection, wear protective equipment, such as gloves.**

Failure to follow this could result in hands getting injured by metal parts.



**At the start-up inspection, shut off the power, and perform inspection.**

**(excluding inspection to be performed when operating this product.)**

Failure to follow this could result in injury due to unexpected operation, such as getting caught and/or stuck.



**When operating this product at the start-up inspection, take appropriate measures to prevent fingers from getting stuck and/or caught in carrier wheels and/or rollers.**

**Also, get ready to shut off the power in the event that something should happen.**

Failure to follow this could result in accidents/injury by getting caught and/or stuck.



**If any abnormalities are found at the start-up inspection, make sure to take countermeasures before the trial run.**

Failure to follow this could result in damage and/or malfunction.

#### 3-6.

#### Precautions on maintenance and inspection

### CAUTION



**If any abnormalities are found, do not use this product until the causes have been eliminated completely .**

Using this product with unattended abnormalities could result in not only damage to the devices, but also unexpected accidents.



**Have specialists (or people who have sufficiently acquired skills) perform maintenance and inspection under instructions by management supervisors.**



**At the time of repair and replacement work, turn off the power to all connecting devices.**

To prevent wraparound for the power circuits and/or signals, shut off the power, wait a sufficient amount of time, and discharge electricity inside the DC power supply equipment.



**At the time of maintenance and inspection, post warning labels so as to prevent unauthorized persons from turning on the power.**

Failure to follow this could result in malfunction and/or unexpected accidents.

### 3. Safety precautions

#### 3-6.

#### Precautions on maintenance and inspection

### CAUTION



When repairing/replacing, wear protective equipment, such as gloves.

Failure to follow this could result in hands getting injured by metal parts.



Do not disassemble sections and/or parts other than those specified.

Failure to follow this could result in malfunction and/or unexpected accidents.



Depending on sections and/or parts to be repaired and/or replaced, they need to be rotated and/or lifted by hand.

Pay attention not to get caught and/or stuck. Failure to follow this could result in injury.



Before the trial operation after repair/replacement,

- Check that the roller drive belts have been mounted properly.
- Check that there is no friction between the moving parts, or between the moving and fixed parts.
- Check that screws/covers previously removed have been securely mounted again.
- Check that all parts are installed.

Failure to follow this could result in malfunction and/or unexpected accidents.



Make sure to prepare repair/replacement parts designated by ITOH DENKI.

Using parts other than those designated by ITOH DENKI could result in malfunction.

# 4. Advance preparation

## 4. Advance preparation

### Wiring image

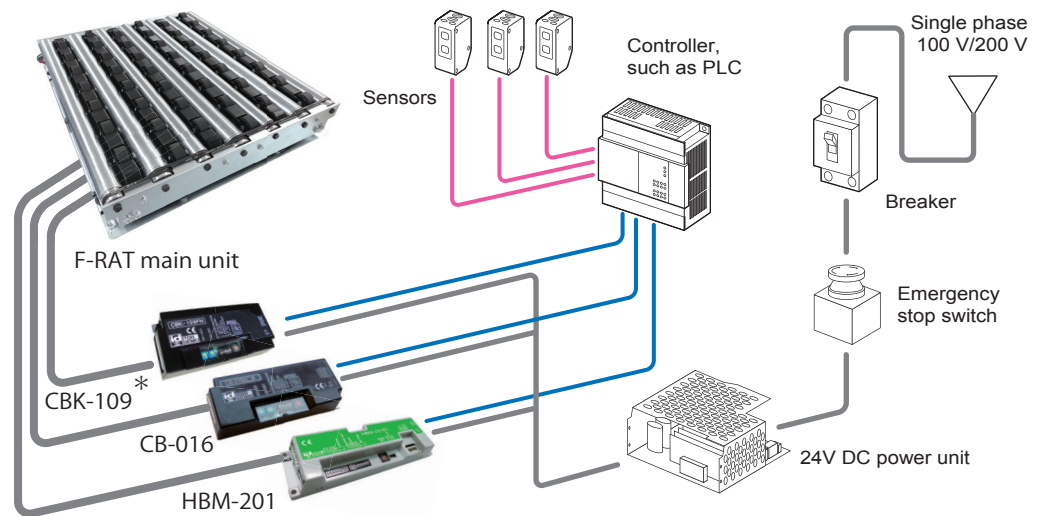

\*1 HBK-608-CP3 is applicable for E1 type.

**【Important】** As for the sensor input, and input/output signals of driver cards, adopt the number of inputs/outputs based on operation.

### Items to be prepared by customers

#### ① 24V DC power supply

Before introducing this product, prepare the following devices separately.

Power supply equipment to supply 24V DC to this product

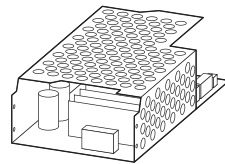

- Switching power supply
  - 24V DC Battery
- <Specification>

Standard type

• 24V DC/8A, 192W or more  
• The power supply must be able to handle 30A peak for 1 msec.

E1 type

• 24V DC/16A, 384W or more  
• The power supply must be able to handle 40.5A peak for 1 msec.



#### Operation

- Since F-RAT uses MDR for each of carrier wheel transfer, roller transfer, and drive switching (3 MDRs in total), it is not recommended to use multiple MDRs at the same time.



- A switching power supply is recommended as the DC power supply (24V DC±10%) for drivers.
- Use stable Power Supply with no fluctuations by varying load and with ampere margin.
- The power supply shall have a capacity larger than the rated value of this product.
- A transformer type power supply cannot be used.
- Secure a voltage of 24V DC±10% at the power supply terminal of a driver card.
- If the capacity of the power supply is less than the rated power of this product, it may cause the supply voltage leading malfunction or damage. Be sure to use the power supply with a capacity larger than the rated power of this product.
- For the power supply unit, use an isolation type switching power supply compliant with the safety standard (IEC62368-1 or UL62368-1). Do not use a non-isolation type power supply for safety reasons, since it may not conform to the radiation noise regulations.

4. Advance preparation

② Control devices

Devices to control this product, such as PLCs

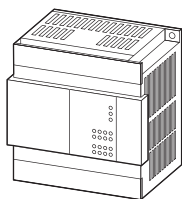

③ Sensors

Zone sensors to check the tray, and area sensors to check loading and discharging, etc.

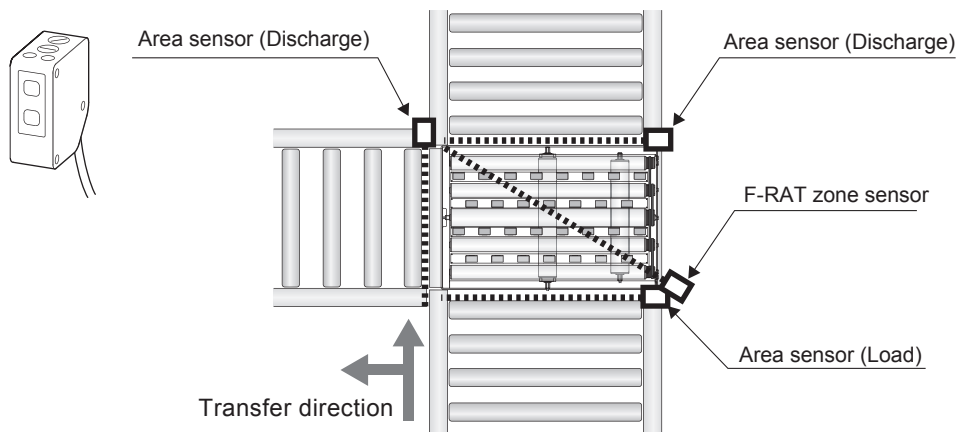

Zone sensor

A sensor to detect the existence of trays within the zone

Area sensor

A sensor to detect load and discharge of trays

Term

④ Wiring materials

Necessary for wiring of power and signal cables, branch connectors, driver cards, controllers, such as sensors or PLCs, and power supply.

〈Available wire diameter for driver card connectors〉

Standard type

Connector \ Driver card	CBK-109	CB-016 / HBM-201
Power connector	0.8~1.5mm <sup>2</sup> (AWG : 18~14)	0.5~1.5mm <sup>2</sup> (AWG : 20~14)
Control connector	0.08~0.5mm <sup>2</sup> (AWG : 28~20)	

E1 type

Connector \ Driver card	HBK-608-CP3	CB-016 / HBM-201
Power connector	2.0~2.5mm <sup>2</sup> (AWG : 14~12)	0.5~1.5mm <sup>2</sup> (AWG : 20~14)
Control connector	0.08~0.5mm <sup>2</sup> (AWG : 28~20)	

- To select the current capacity of wiring materials, secure a high safety margin based on the current value in the equipment to be used.
- Longer wiring between the power supply unit and driver cards/controllers could cause the voltage to decrease, resulting in malfunction and/or damage.

## 4. Advance preparation

### ⑤ MDR extension cable (option)

Necessary when the installing location of the F-RAT main unit is far from that of the driver cards.

#### ■ CBK-109 \* : 12P extension cable

Model	12P extension cable length
ACE-CBM-G0600	L= 600mm
ACE-CBM-G1200	L=1200mm

\* HBK-608-CP3 is applicable for E1 type

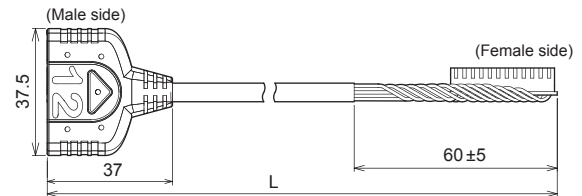

#### ■ CB-016 / HBM-201 : 10P extension cable

Model	10P extension cable length
ACE-CBM-A0600	L= 600mm
ACE-CBM-A0850	L= 850mm
ACE-CBM-A1200	L=1200mm

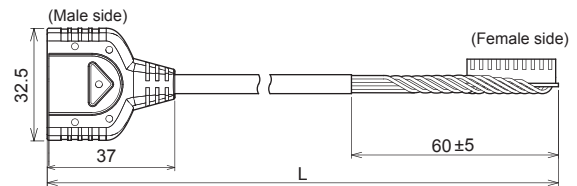

■ Use extension cables of 1200 mm or less.

■ Do not extend cables by connecting multiple extension cables.

### ⑥ Stay (option)

Size	L (mm)	X (mm)
6040 / 7540 / 9040	370	400
6050 / 7550 / 9050	470	500
6060 / 7560 / 9060	570	600
6070 / 7570 / 9070	670	700
6080 / 7580 / 9080	770	800

\* For X dimensions (between frames) other than those mentioned above, contact us.

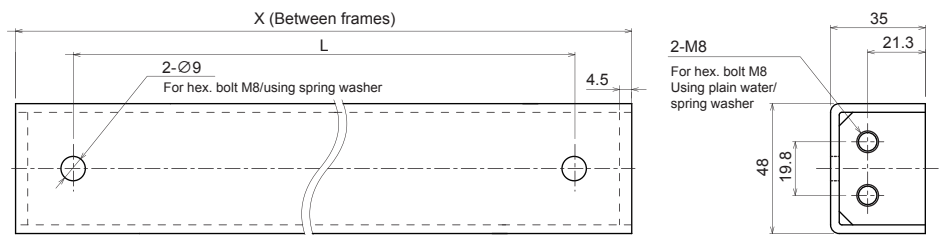

### ⑦ Emergency stop equipment



This product does not include the emergency stop equipment. Customers must make sure to install it.

Install the emergency stop equipment on the side of the 24V DC power unit to which the power is supplied.

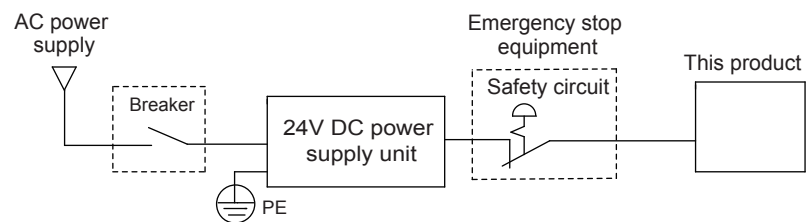

#### ⑦-1 Checking the breaker

Regarding equipment where this product is installed, check that a breaker with appropriate capacity for AC input specifications of the 24V DC power supply unit has been installed. If abnormal operation should occur, protection through the breaker could be effective.

Note that when using an earth leakage breaker, select one that is "inverter corresponding". Some inverter non-corresponding earth leakage breakers could result in malfunction, since they may recognize high-frequency components of the switching power supply as leakage.

#### ⑦-2 Operation check

When the 24V DC power supply unit has been installed, check that the breaker and safety circuit can work properly. Perform operation following the trial operation after checking them.

- ① Input to the 24V DC power supply unit (AC power) is securely turned ON/OFF when turning ON/OFF the breaker.
- ② This product input (24V DC) is securely turned OFF/ON when turning ON/OFF the safety circuit.

4. Advance preparation

⑧ About the wiring method

⑧-1 When overcurrent protection devices are required

When overcurrent protection devices need to be installed to the 24V DC power supply unit, some power supplies that need to conform to the safety standards (UL62368-1, etc.) require installation of the specified overcurrent protection device based on their specifications. In such cases, make sure to install the specified overcurrent protection device as described in the figure below. When overcurrent protection devices are not required in specifications of the 24V DC power supply unit, they do not need to be installed.

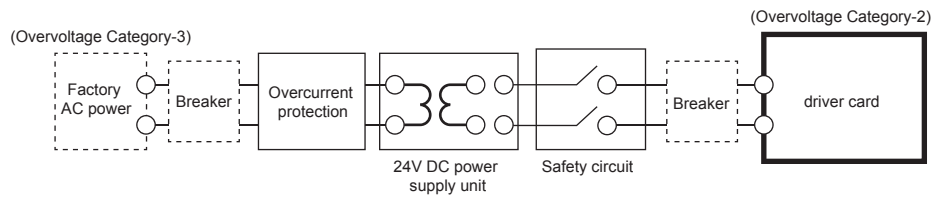

⑧-2 Installation of over-current protection device

In case of using power supply device except a limit power supply, install the over-current protection device on the 24V DC line.

⑧-3 Adding the power shutdown circuit of this product in the event of a failure

In the event that a failure occurs, such as overload or abnormal temperature, driver card will transmit the data of failure generation to PLC devices, as well as stopping product operation. However, the product does not have the power shutdown function. Accordingly, if the product's power needs to be shut down in the event of a failure, as described in SW1 of the figure below, add the power shutdown circuit using a PLC.

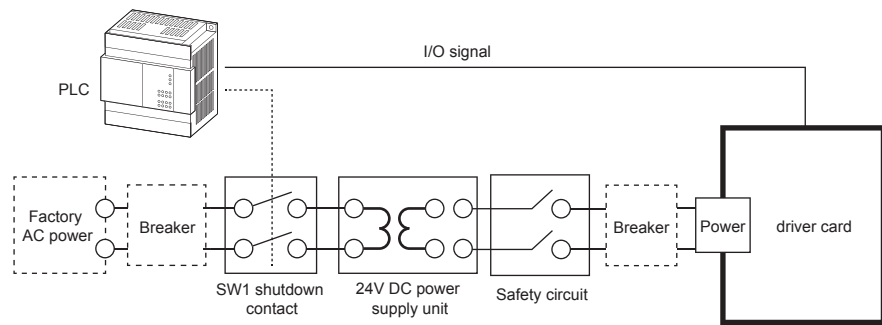

**!** At the time of power shutdown, not only the F-RAT main unit power, but also the driver card control power will be shut down.

Safety precautions

Advance preparation

Product check

Structures

Installation/Wiring

Control/Operation

Maintenance/Inspection

Troubleshooting

Appendix

# 5. Product check

5. Product check

Checking the model

Unpack the product, and check that the product model is as ordered.

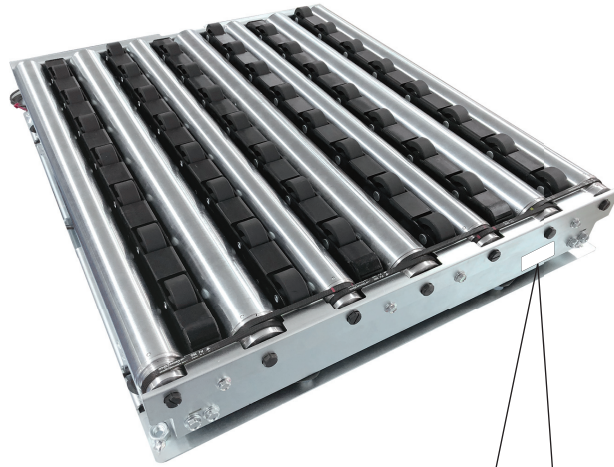

< Product label details >

Model →	<p>FLAT RIGHT ANGLE TRANSFER                  F-RAT-NX75-F60-7540-CN-S3                  RATED INPUT: DC24V / 4.9A                  RATED POWER: 56W                  PAYLOAD: max 50 kg                  SERIAL No:                  MFG. YEAR:                      DOC:</p>
---------	--

Checking appearance

- ① Check that the main unit is free from any abnormalities, such as traces of scratches, dents, dirt, and/or corrosion (rust).
  - ② Check that there is no omission and/or looseness of screws, etc.
- \* If any abnormalities are found, contact the supplier immediately.

5. Product check

Checking accessories

Driver cards

Check that all the following items are included.

Depending on the F-RAT input and output signal type, driver cards with the NPN (N) or PNP (P) signal input are included. (Not included when no driver card type is specified.)

Standard type 

For F-RAT-NX75-□□□-□□□□-CN-S3

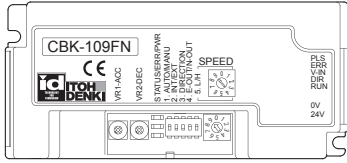

Driver card **CBK-109FN**  
〈 For carrier wheel transfer 〉

1

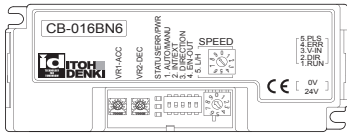

Driver card **CB-016BN6**  
〈 For roller transfer 〉

1

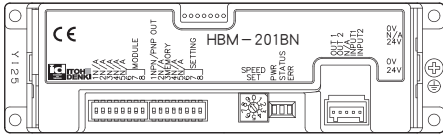

Driver card **HBM-201BN**  
〈 For drive switching 〉

1



Power connector  
〈 common to each driver card 〉  
WAGO 734-102 (EAHB05)

3



Cross-recessed head SW screw M4 x 15/Hex. nut M4  
〈 For securing each driver card 〉

8 sets

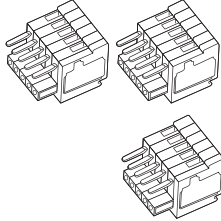

Control connector  
〈 common to each driver card 〉  
WAGO 733-105 (PACB16)

3

---

For F-RAT-NX75-□□□-□□□□-CP-S3

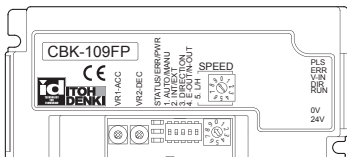

Driver card **CBK-109FP**  
〈 For carrier wheel transfer 〉

1

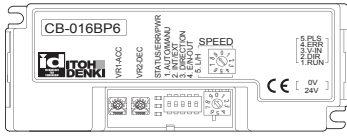

Driver card **CB-016BP6**  
〈 For roller transfer 〉

1

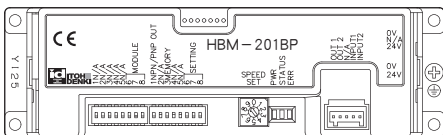

Driver card **HBM-201BP**  
〈 For drive switching 〉

1



Power connector  
〈 common to each driver card 〉  
WAGO 734-102 (EAHB05)

3



Cross-recessed head SW screw M4 x 15/Hex. nut M4  
〈 For securing each driver card 〉

8 sets

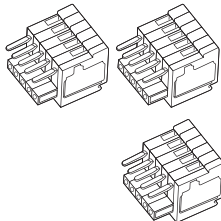



Control connector  
〈 common to each driver card 〉  
WAGO 733-105 (PACB16)

3

5. Product check

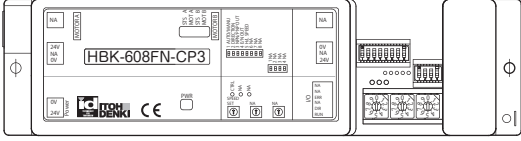
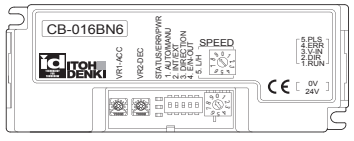
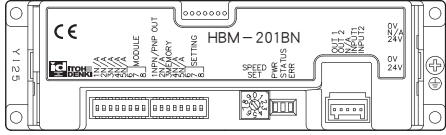
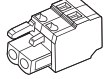

E1 type 

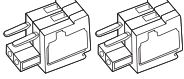
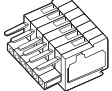
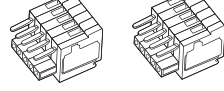
**For F-RAT-NX75-F□□-(7580/9070/9080)-CN-E1**

 <p>Driver card <b>HBK-608FN-CP3</b> 〈 For carrier wheel transfer 〉</p> <div style="border: 1px solid black; width: 40px; margin: 0 auto; text-align: center; padding: 2px;">1</div>	 <p>Driver card <b>CB-016BN6</b> 〈 For roller transfer 〉</p> <div style="border: 1px solid black; width: 40px; margin: 0 auto; text-align: center; padding: 2px;">1</div>	
<p>■ Power connector</p>		
 <p>Driver card <b>HBM-201BN</b> 〈 For drive switching 〉</p> <div style="border: 1px solid black; width: 40px; margin: 0 auto; text-align: center; padding: 2px;">1</div>	 <p>HBK-608FN-CP3 WAGO 231-302-026-000</p> <div style="border: 1px solid black; width: 40px; margin: 0 auto; text-align: center; padding: 2px;">1</div>	
<p>■ Control connector</p>		
 <p>Cross-recessed head SW screw M4 x 15/Hex. nut M4 〈 For securing each driver card 〉</p> <div style="border: 1px solid black; width: 40px; margin: 0 auto; text-align: center; padding: 2px;">8 sets</div>	 <p>CB-016BN6 / HBM-201FN WAGO 734-102 (EAHB05)</p> <div style="border: 1px solid black; width: 40px; margin: 0 auto; text-align: center; padding: 2px;">2</div>	
 <p>HBK-608FN-CP3 WAGO 733-106</p> <div style="border: 1px solid black; width: 40px; margin: 0 auto; text-align: center; padding: 2px;">1</div>		 <p>CB-016BN6 / HBM-201FN WAGO 733-105 (PACB16)</p> <div style="border: 1px solid black; width: 40px; margin: 0 auto; text-align: center; padding: 2px;">2</div>

---

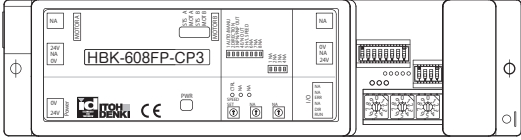
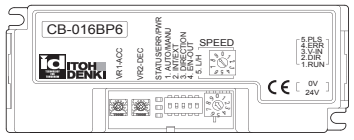
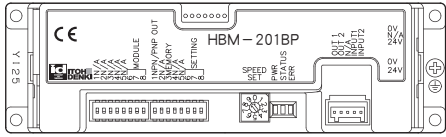
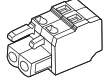
**For F-RAT-NX75-F□□-(7580/9070/9080)-CP-E1**

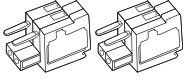
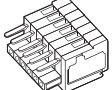
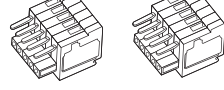
 <p>Driver card <b>HBK-608FP-CP3</b> 〈 For carrier wheel transfer 〉</p> <div style="border: 1px solid black; width: 40px; margin: 0 auto; text-align: center; padding: 2px;">1</div>	 <p>Driver card <b>CB-016BP6</b> 〈 For roller transfer 〉</p> <div style="border: 1px solid black; width: 40px; margin: 0 auto; text-align: center; padding: 2px;">1</div>	
<p>■ Power connector</p>		
 <p>Driver card <b>HBM-201BP</b> 〈 For drive switching 〉</p> <div style="border: 1px solid black; width: 40px; margin: 0 auto; text-align: center; padding: 2px;">1</div>	 <p>HBK-608FP-CP3 WAGO 231-302-026-000</p> <div style="border: 1px solid black; width: 40px; margin: 0 auto; text-align: center; padding: 2px;">1</div>	
<p>■ Control connector</p>		
 <p>Cross-recessed head SW screw M4 x 15/Hex. nut M4 〈 For securing each driver card 〉</p> <div style="border: 1px solid black; width: 40px; margin: 0 auto; text-align: center; padding: 2px;">8 sets</div>	 <p>CB-016BP6 / HBM-201FP WAGO 734-102 (EAHB05)</p> <div style="border: 1px solid black; width: 40px; margin: 0 auto; text-align: center; padding: 2px;">2</div>	
 <p>HBK-608FP-CP3 WAGO 733-106</p> <div style="border: 1px solid black; width: 40px; margin: 0 auto; text-align: center; padding: 2px;">1</div>		 <p>CB-016BP6 / HBM-201FP WAGO 733-105 (PACB16)</p> <div style="border: 1px solid black; width: 40px; margin: 0 auto; text-align: center; padding: 2px;">2</div>

  
 Hex. bolt with spring lock and plain washers M8 x 20  

4 sets

For installing the F-RAT main unit

# 6. Structures

6. Structures

Structures

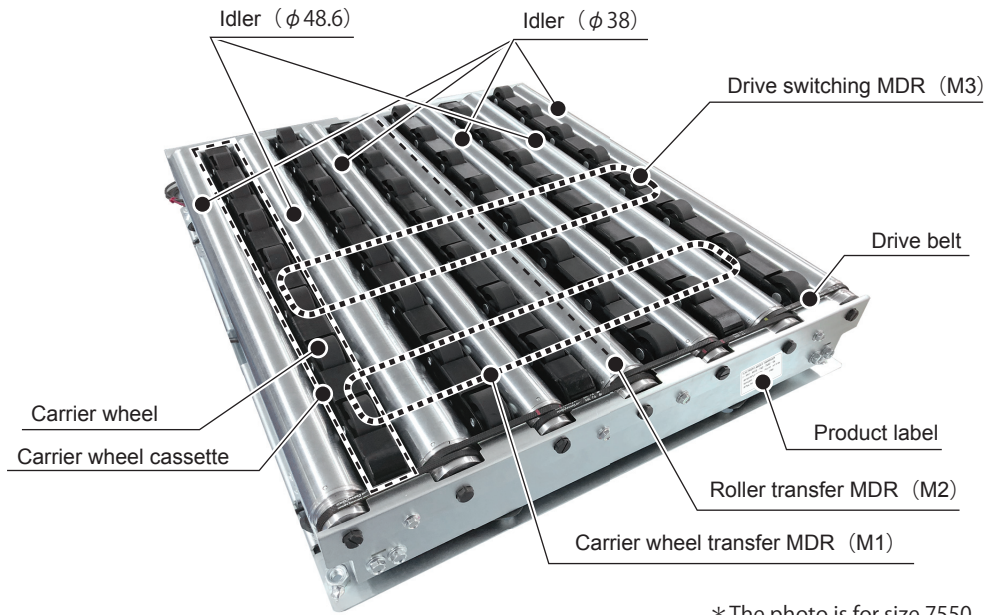

\* The photo is for size 7550.

Product designation

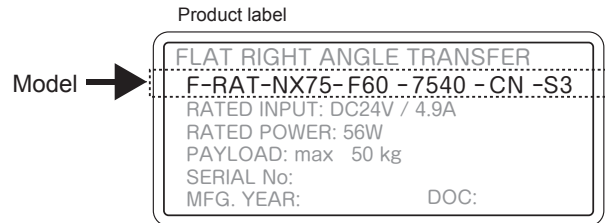

**F-RAT-NX75-F60-7540-CN-S3**

- ① Motor specifications
  - F ... FE 10P connector type
- ② Nominal speed
  - 17 ... Nominal speed 17m/min type
  - 60 ... Nominal speed 60m/min type
  - \* For details, refer to 8-3. Changing the transfer speed (P.47).
- ③ Size (L direction)
  - 60 (L595mm)
  - 75 (L745mm)
  - 90 (L895mm)
- ④ Size (W direction)
  - 40 (W395mm)
  - 50 (W495mm)
  - 60 (W595mm)
  - 70 (W695mm)
  - 80 (W795mm)
- ⑤ Included driver cards
  - C ... Standard driver cards (CBK-109\* / CB-016 / HBM-201)
  - E ... Driver cards to support network communications (IB-E04F-FT / HBM-201)
  - \* Becomes blank when no driver card has been specified.
  - HBK-608-CP3 is applicable for E1 type.
- ⑥ Input and output signal type
  - N ... NPN (Included with driver cards only for input and output)
  - P ... PNP (Included with driver cards only for input and output)
  - Becomes blank when no driver card has been specified.
- S3 ... Standard type
- E1 ... E1 type

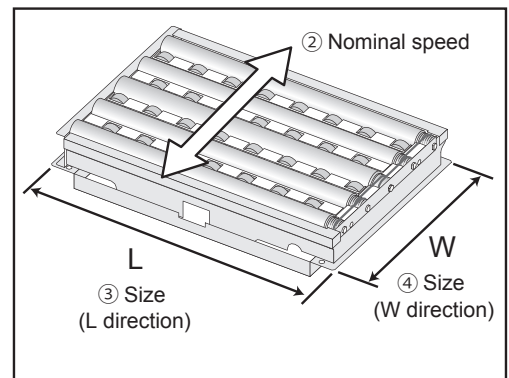

Nominal speed

This is nominal speed, not actual transferring speed.

Term

# 7. Installation/Wiring

7-1. Before installation	.....	26
7-2. Installation	.....	36
7-3. Wiring	.....	38

**7. Installation/Wiring**

**7-1.**

Before installation

- Prepare stands, and perform frame processing in advance by reference to the mounting holes in dimensions.
- Determine the mounting location for zone sensors to check the existence of trays, and area sensors to check loading and discharging. Then, prepare for them to be mounted.

Mounting preparation for the F-RAT main unit

Size 6040  
L595mm×W395mm

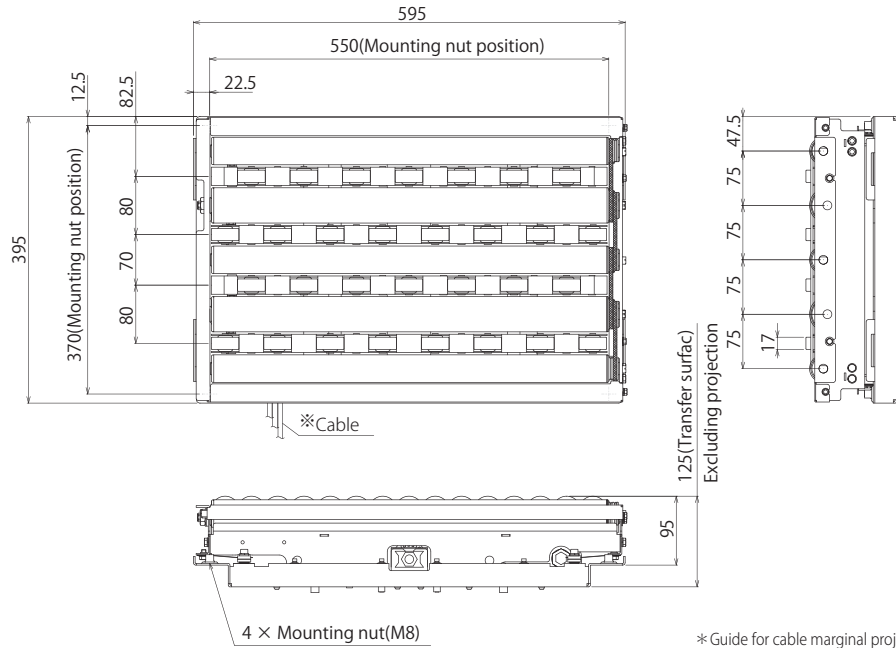

\* Guide for cable marginal projecting length (mm)

M1 : Carrier wheel transfer MDR	1000
M2 : Roller transfer MDR	1100
M3 : Drive switching MDR	1300

Size 6050  
L595mm×W495mm

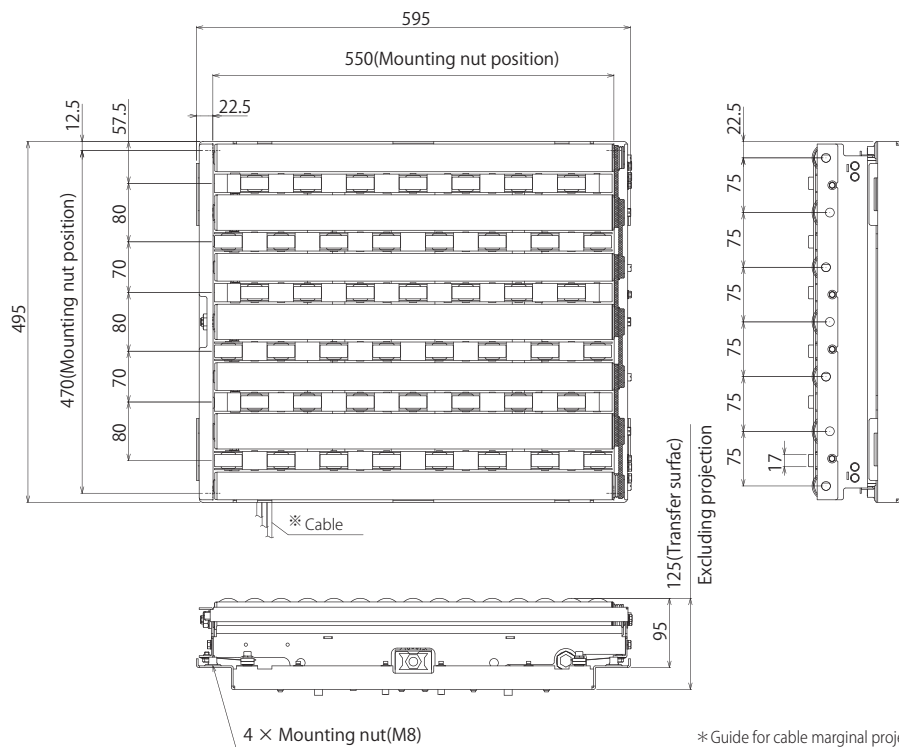

\* Guide for cable marginal projecting length (mm)

M1 : Carrier wheel transfer MDR	1000
M2 : Roller transfer MDR	1000
M3 : Drive switching MDR	1300

**7. Installation/Wiring**

Size 6060  
L595mm×W595mm

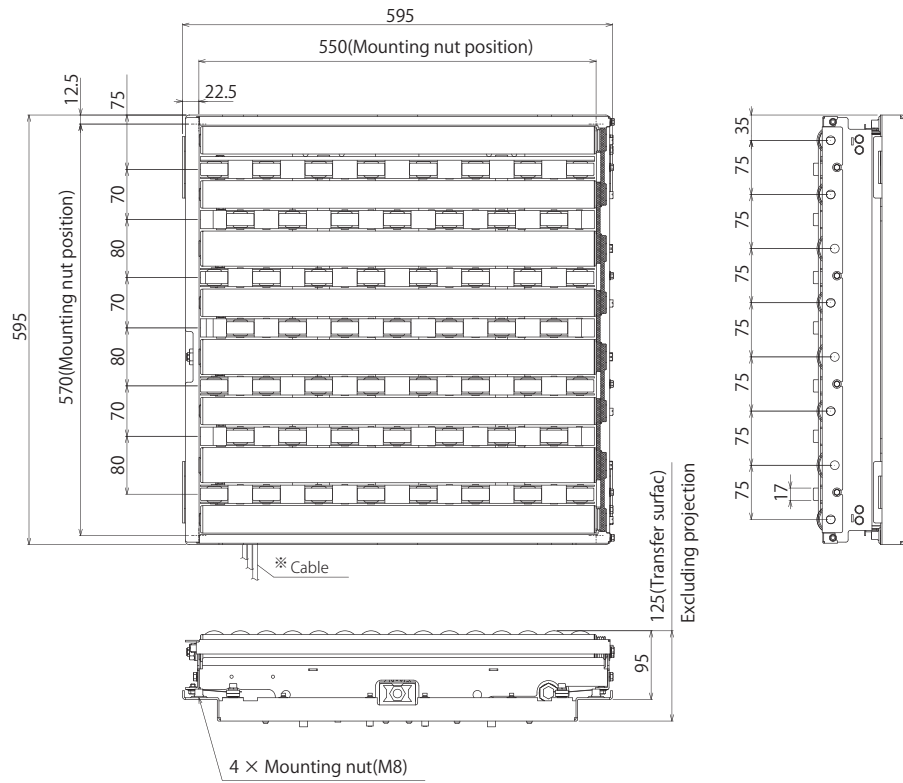

\* Guide for cable marginal projecting length (mm)

M1 : Carrier wheel transfer MDR	1000
M2 : Roller transfer MDR	900
M3 : Drive switching MDR	1300

Size 6070  
L595mm×W695mm

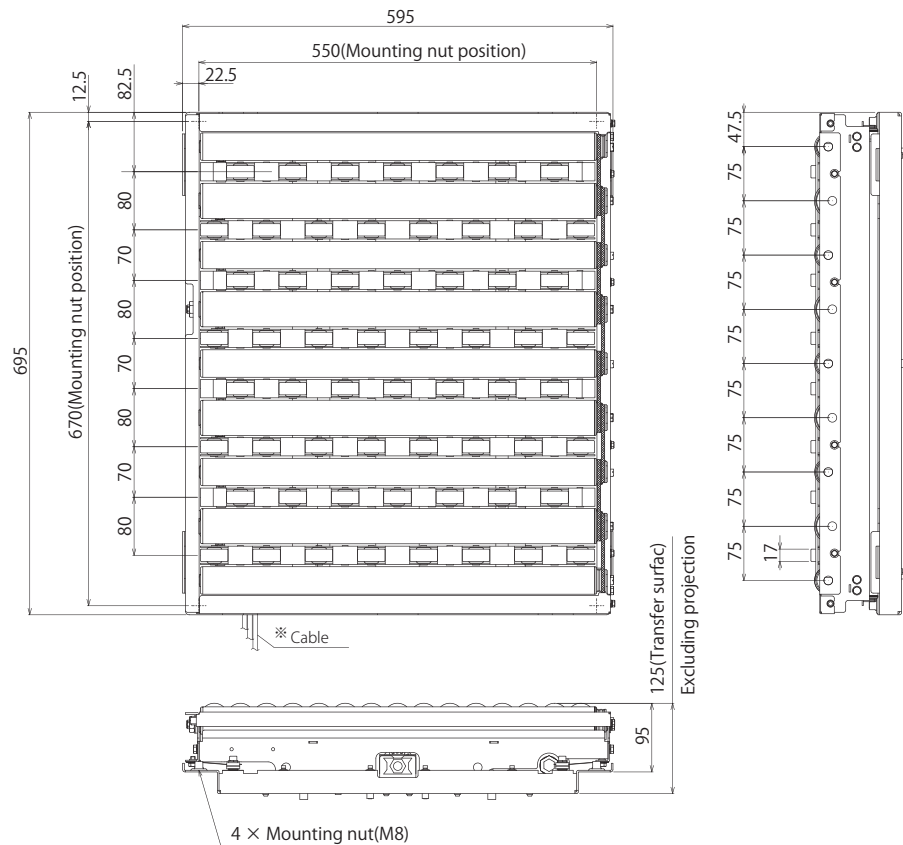

\* Guide for cable marginal projecting length (mm)

M1 : Carrier wheel transfer MDR	1000
M2 : Roller transfer MDR	800
M3 : Drive switching MDR	1300



**7. Installation/Wiring**

Size 7550  
L745mm×W495mm

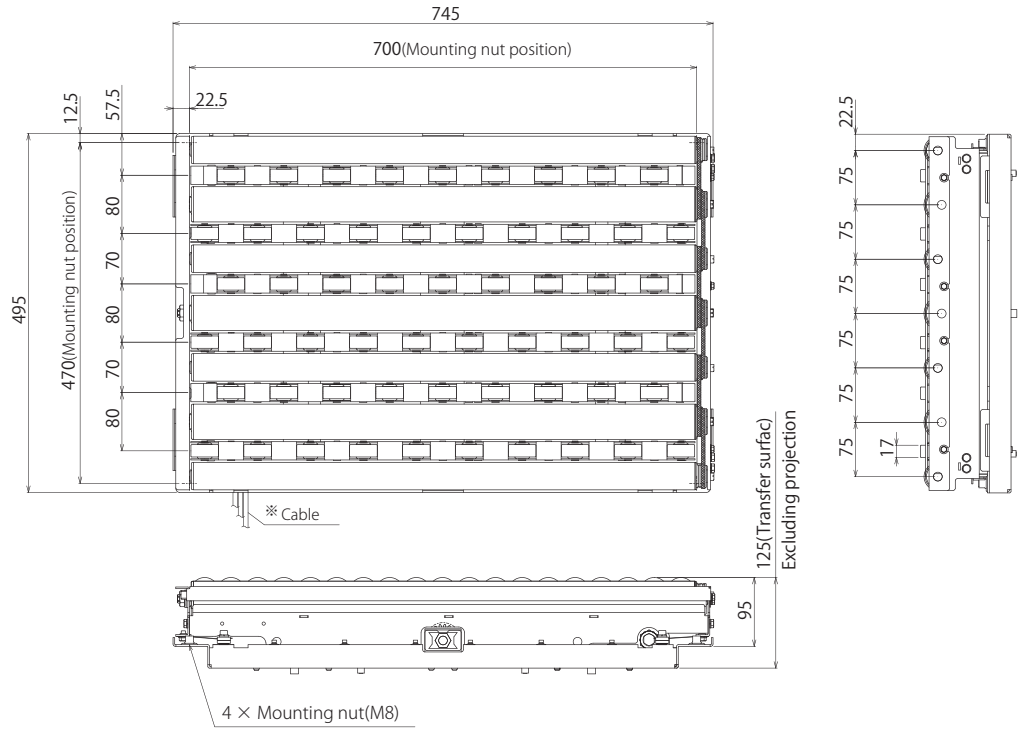

\* Guide for cable marginal projecting length (mm)

M1 : Carrier wheel transfer MDR	850
M2 : Roller transfer MDR	1000
M3 : Drive switching MDR	1200

Size 7560  
L745mm×W595mm

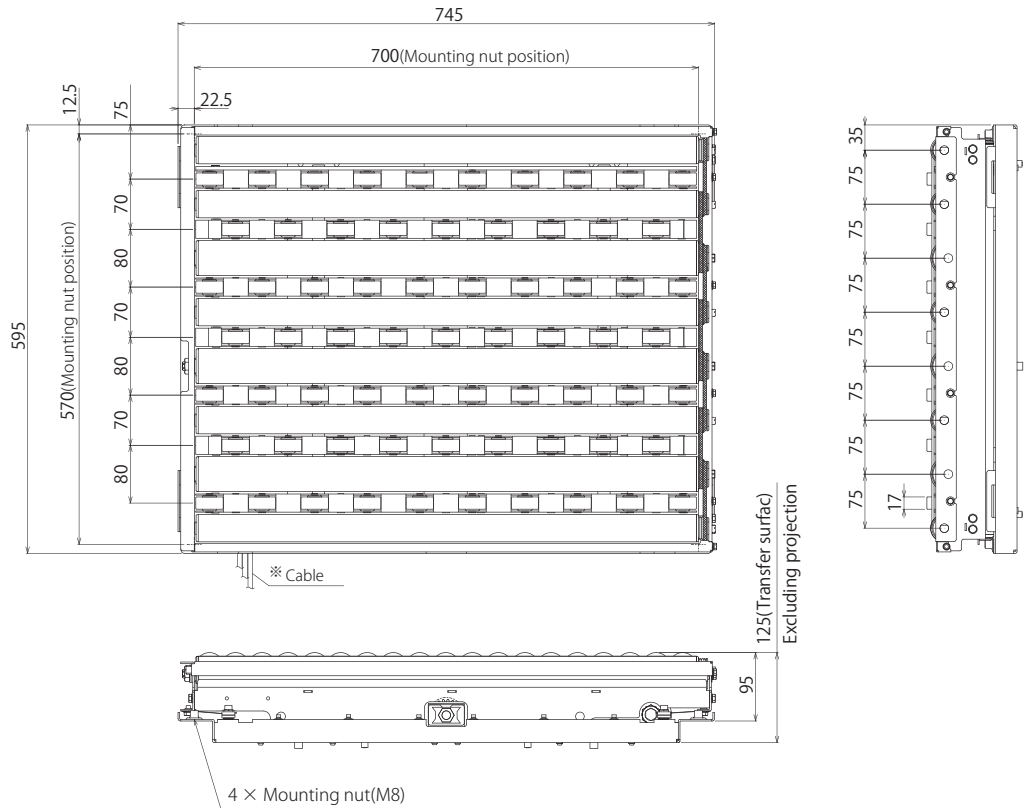

\* Guide for cable marginal projecting length (mm)

M1 : Carrier wheel transfer MDR	850
M2 : Roller transfer MDR	900
M3 : Drive switching MDR	1200

7. Installation/Wiring

Size 7570  
L745mm×W695mm

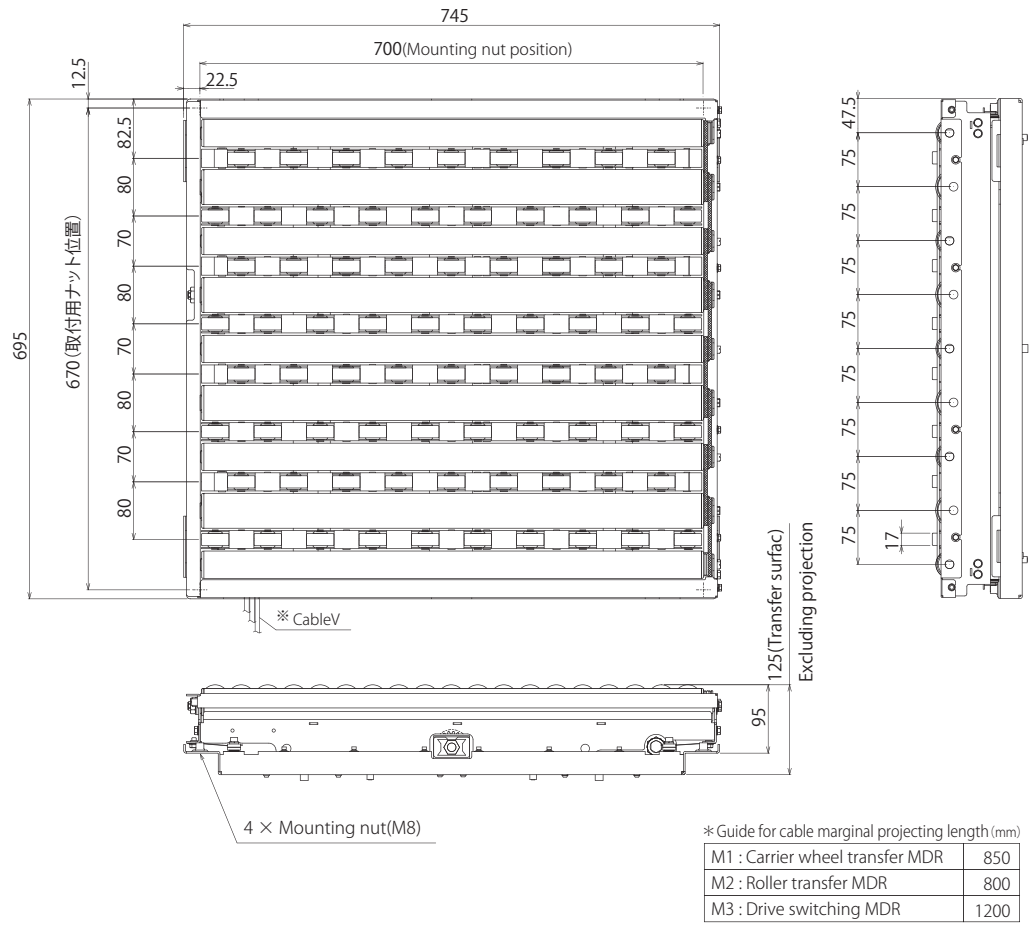

Size 7580  
L745mm×W795mm

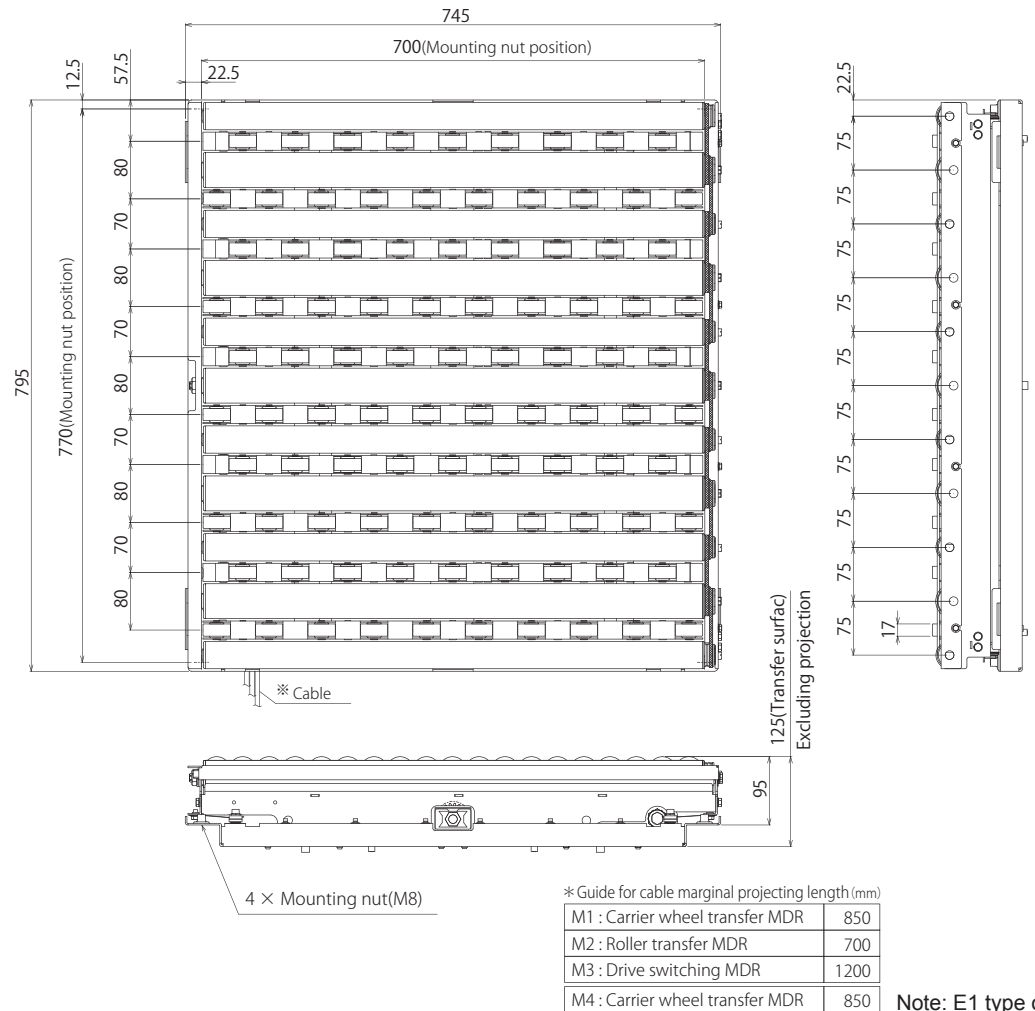

Note: E1 type only





**7. Installation/Wiring**

Size 9080  
L895mm×W795mm

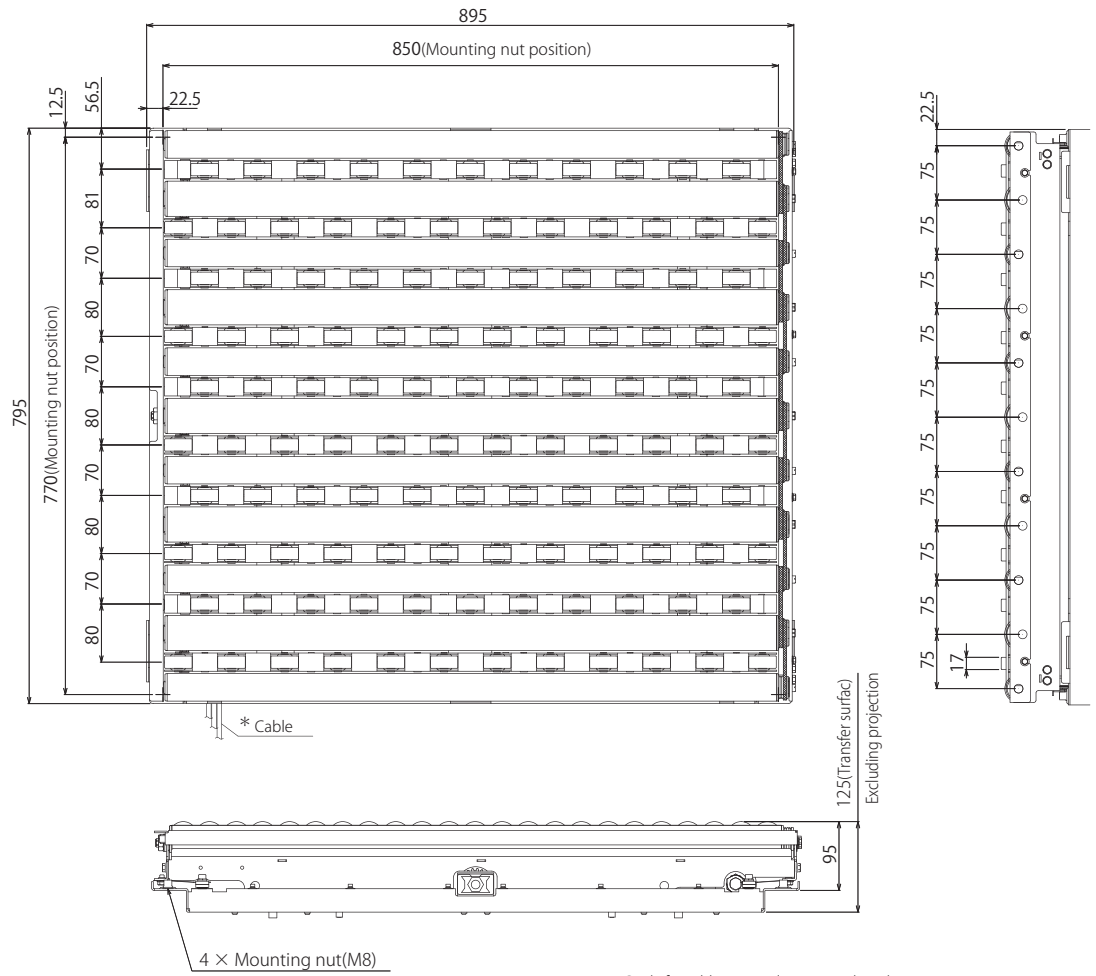

\* Guide for cable marginal projecting length (mm)

M1 : Carrier wheel transfer MDR	700
M2 : Roller transfer MDR	700
M3 : Drive switching MDR	1100
M4 : Carrier wheel transfer MDR	700

Note: E1 type only



## 7. Installation/Wiring

### Preparation of MDR extension cables

If the mounting location of the F-RAT main unit is far from that of driver cards, prepare the MDR extension cables separately.

- For CBK-109 (12P extension cable) : ACE-CBM-G○○○○○
- For CB-016 / HBM-201 (10P extension cable) : ACE-CBM-A○○○○○



- Use extension cables of 1200 mm or less.
- Do not extend cables by connecting multiple extension cables.

### Mounting preparation for sensors

Determine the mounting location for zone sensors, and area sensors for loading and discharging, and prepare for them to be mounted.

Example)  
Mounting positions  
for each sensor

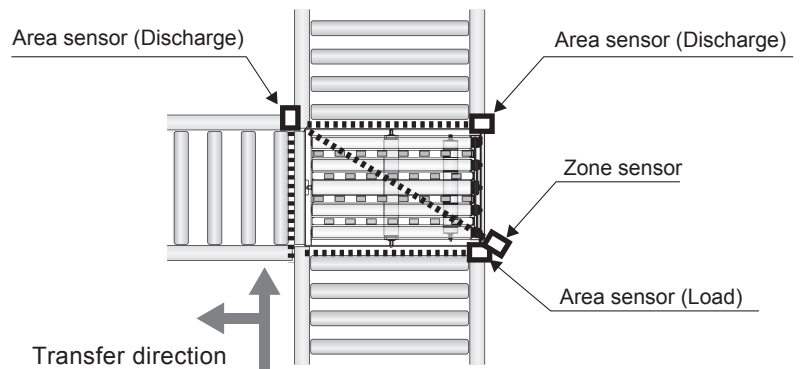

7. Installation/Wiring

7-2. Installation

Installing the F-RAT main unit

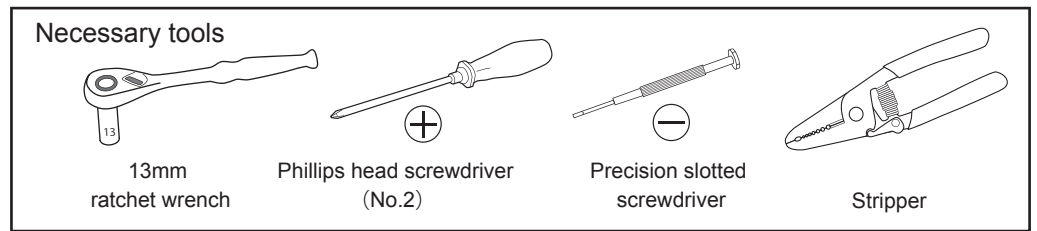

Installing the F-RAT main unit

1 Carry this product to the installing location.

- When lifting, hold the bottom of this product. Do not hold the moving parts, such as rollers, belt transfer parts, or lifting sections.

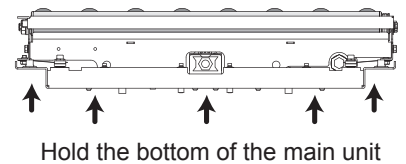

2 Check the installing direction for the loading/discharging sides.

- Check the direction of V-ribbed pulley.

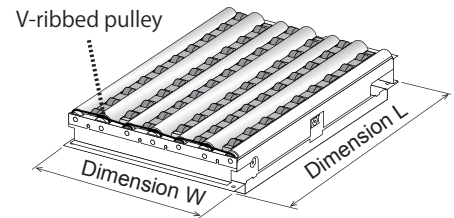

3 Use the included bolts to secure the unit on stands or stays with the mounting nuts for the F-RAT main unit.

- When installing, be careful not to get fingers caught.
- Install this product in places with a mounting surface tilt (inclination) of 0.5% or less.
- Install in locations where the weight of this product and trays can be sufficiently supported. (For the main unit weight, refer to P.72)
- The vibration level in the installation environment for this product should be 0.5 G or less.
- Secure the working space for maintenance around this product.
- Observe safety regulations required for installation locations or equipment in use.
- Recommended tightening torque: 12 to 15 N·m

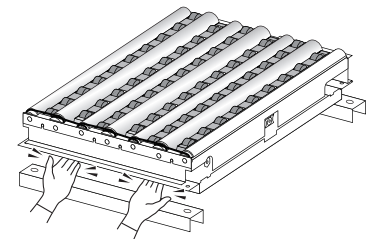

Mounting example using stays

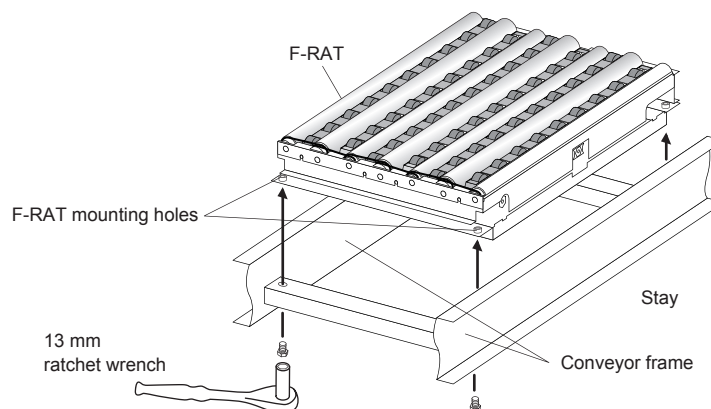

4 Adjust the conveyor frame legs on which the F-RAT main unit has been mounted, and align levels of the F-RAT main unit and the adjacent conveyor.

7. Installation/Wiring

About stays (option)

Dedicated stay (optional) is prepared for F-RAT installation.



■ If users do not use the stays, be sure to use the mounting holes on the F-RAT main unit to secure the F-RAT. In addition, comply with the mounting dimensions for stays, as well as mount them by taking into consideration the weight of this product and trays.

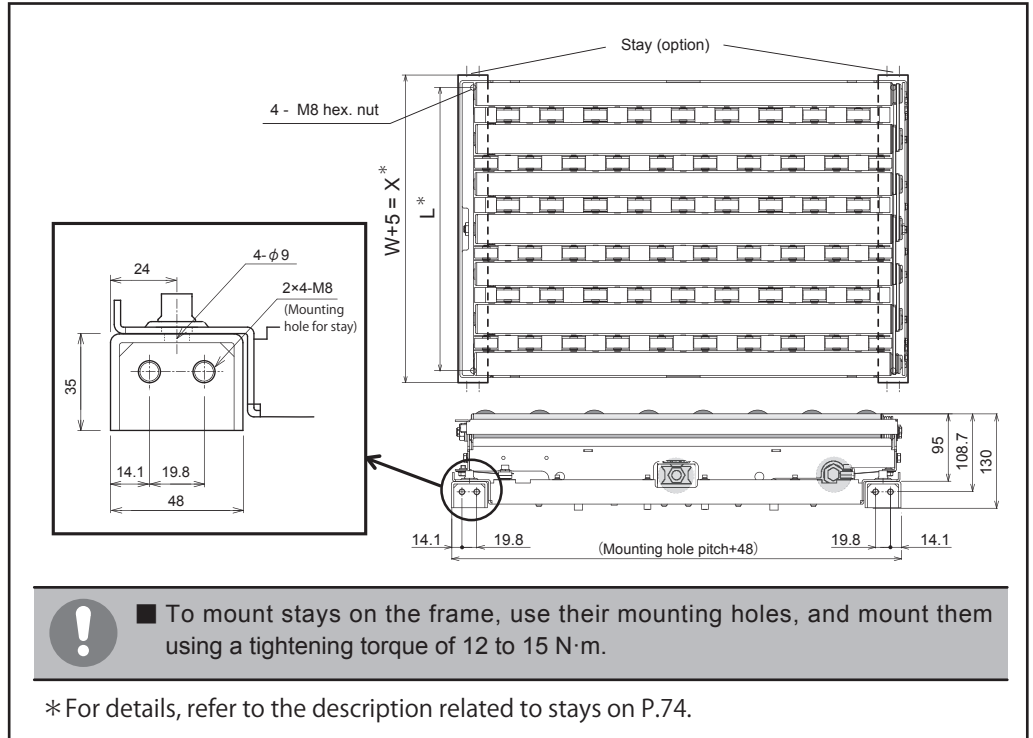

Mounting driver cards

■ Mounting driver cards

Use the included screws and nuts to mount driver cards on the conveyor frames or control panel.



■ Recommended tightening torque: \*  
1.5 to 1.9N·m

\* 0.53 to 0.63 N·m recommended tightening torque for HBK-608-CP3.

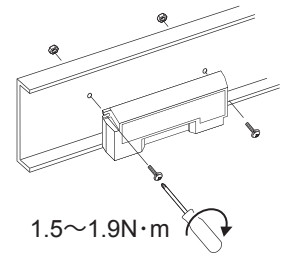

Mounting sensors,  
control devices, and  
power supply units

■ Mounting sensors, control devices, and power supply units

Mount customer-prepared zone sensor and area sensor for loading and discharging, as well as power supply units, and PLCs.

## 7. Installation/Wiring



7-3.

### Wiring

#### Connection between the F-RAT main unit and driver cards

#### Connection between the F-RAT main unit and driver cards

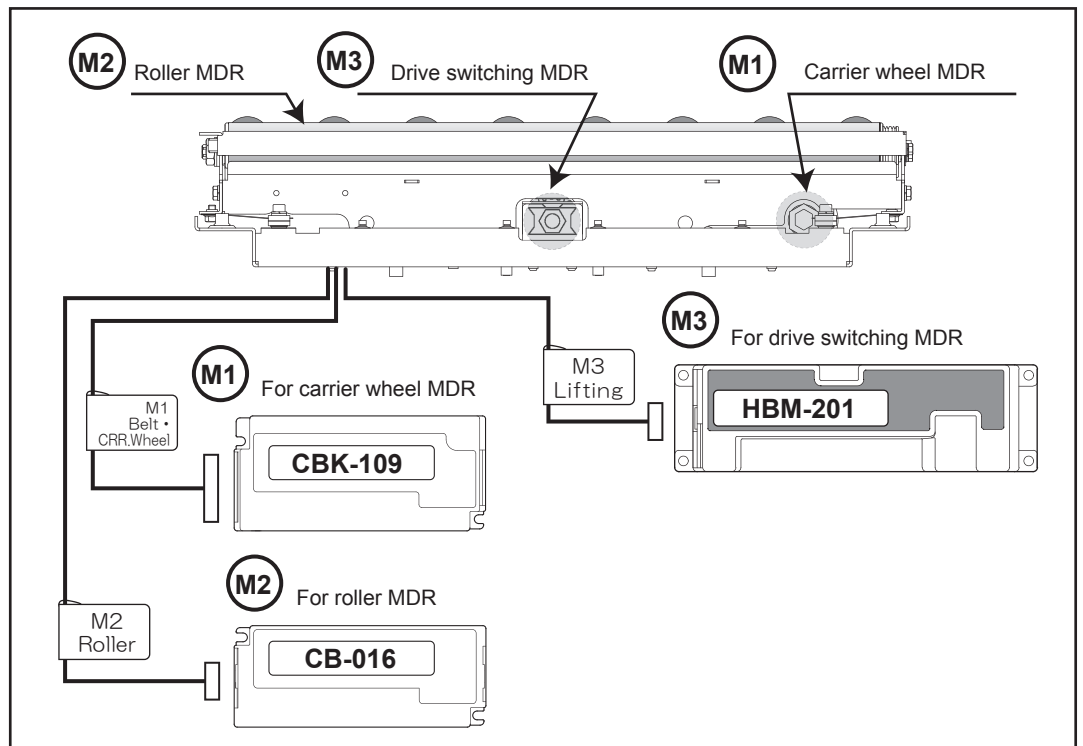
- Refer to the labels for cables coming from the F-RAT main unit, and securely connect the MDR connectors and driver cards.
- When using extension cables, securely connect them to the MDR connectors, as well as to the driver card connectors.

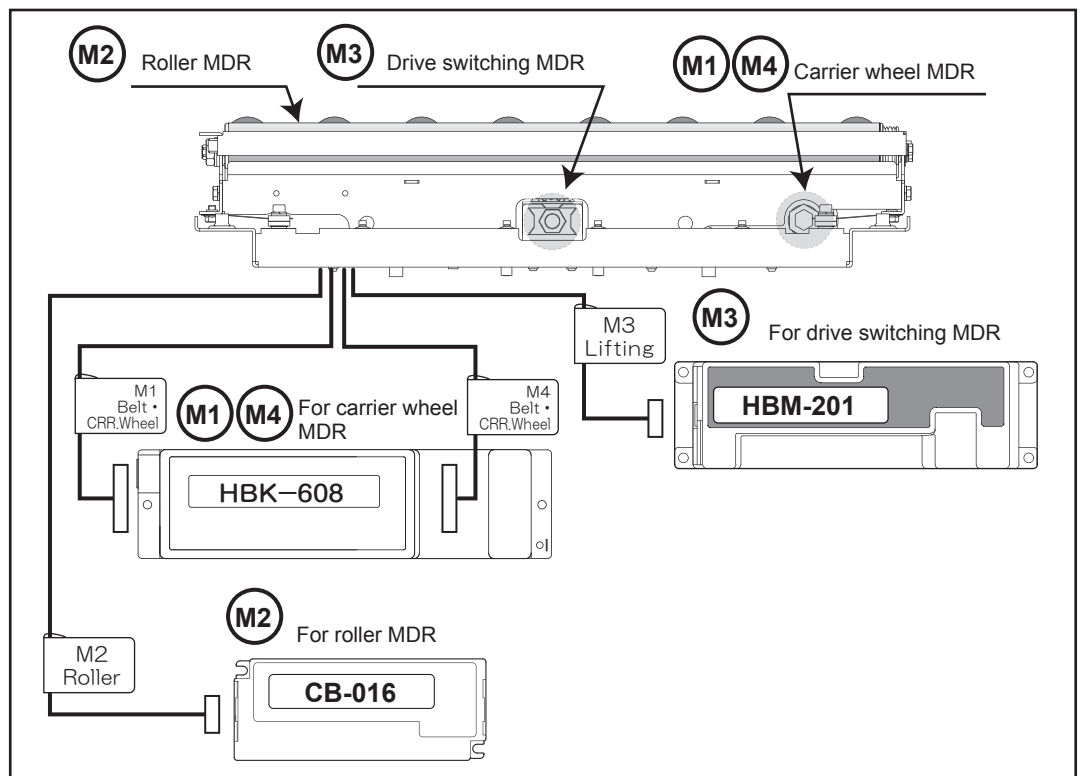
Standard type E1 type 

7. Installation/Wiring

Standard type 

M1 : For carrier wheel transfer

Wiring for CBK-109

CBK-109

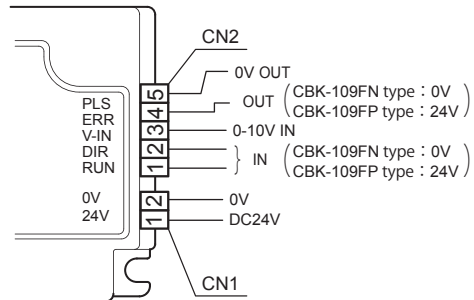

Connector descriptions

CN1 (Power)	#2	0V
	#1	24V DC

		Functions	Detailed descriptions
CN2 (Control)	#5	Output Motor pulse output	<ul style="list-style-type: none"> <li>Outputs 2-pulse signal per rotation of the internal motor.</li> <li>NPN open collector output. (NPN output only)</li> <li>Attach protection resistance so that the output is 25 mA or less.</li> <li>Protection resistance of 100 Ω is included inside driver cards.</li> </ul>
	#4	Output Error signal output	<ul style="list-style-type: none"> <li>Detects MDR errors, and outputs.</li> <li>Settings for normal output and error output can be specified using ON/OFF on DIP-SW1#4.</li> <li>Open collector output. (CBK-109FN : 0V / CBK-109FP : 24V)</li> <li>Attach protection resistance so that the output is 25 mA or less.</li> <li>Protection resistance of 100 Ω is included inside driver cards.</li> </ul>
	#3	Analog input MDR external speed setting	The transfer speed can be set by the voltage input of 0 - 10V.
	#2	Input MDR rotation direction switching	The transfer direction can be switched.
	#1	Input MDR RUN/STOP	Required for RUN/STOP signals.

Power connector (CN1)

1 Connect the 24V DC and 0V DC cables to CN1 (2 pin).



- Do not connect multiple power cables to one pole. Failure to follow this could result in electric shock, short circuit, and/or damage due to the capacity of connectors being exceeded. (Connector capacity: 10 A)
- Do not connect the 24V DC and 0V DC cables incorrectly.
- Do not connect cables when connectors are plugged in.

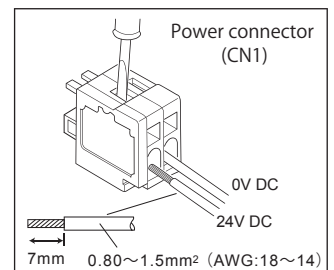

Control connector (CN2)

2 Connect each cable to CN2 (5 pin).  
\* Refer to the above, and perform wiring according to operation.



- Use the same voltage to be input to CN2#1 (MDR RUN/STOP) and CN2#2 (MDR rotation direction) as the power supply voltage. (Connector capacity: 4A)
- When connecting a relay coil, etc., to the remote output, use surge protector devices or add diode for surge protection. Using devices without surge protection measures could result in damage to the remote output terminal, if counter electromotive voltage is generated when switching the output signal.

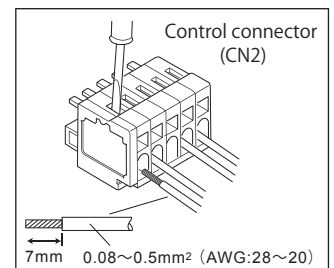

Connecting to driver cards

3 Connect the power connector (CN1), control connector (CN2), and M1 MDR connector to driver cards.

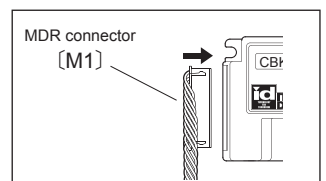

For more details on CBK-109, please download the driver card user manual from our web page.

ITOH DENKI  Home > Download/Support > User Manual  
<http://itohdenki.co.jp/english/support/manual.html>



7. Installation/Wiring

E1 type

M1, M4 :  
For carrier wheel transfer

Wiring for HBK-608-CP3 • Functions

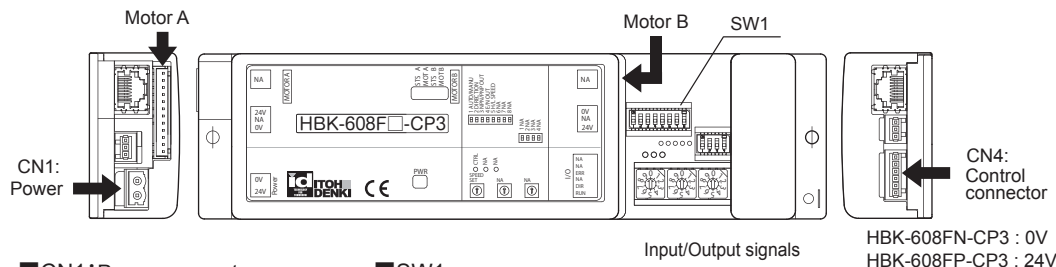

■ CN1: Power connector

CN1	No.	Functions
2	1	DC 24V
1	2	0V

■ SW1

SW1	Functions	ON	OFF	Factory Setting
# 1	Selects error recovery	Manual	Automatic	ON
# 2	MDR rotation direction switching	※1		OFF
# 3	Selects PNP or NPN output	PNP	NPN	※2
# 4	Error signal	Discharges in normal status	Discharges when error arises	OFF
# 5	Speed range	High range	Low range	ON
# 6/7/8	NA	—	—	OFF

※1 The MDR's direction of rotation is determined by a combination of SW1#2 and CN2#2. (refer to P.51)

※2 HBK-608FN-CP3:OFF / HBK-608FP-CP3:ON

■ CN4: Control connector

	Functions	Detailed descriptions
	# 1 Input RUN	MDR Run/Stop Required for RUN/STOP signals.
	# 2 Input DIR	MDR rotation direction switching The transfer direction can be switched.
	# 3 — NA	— NA
	# 4 Output ERR	Error signal output • Detects MDR errors, and outputs. • Settings for normal output and error output can be specified using ON/OFF on DIP-SW1#4. • Open collector output. • Attach protection resistance so that the output is 25 mA or less. • Protection resistance of 100 Ω is included inside driver cards.
	# 5 / 6 — NA	— NA

Power connector (CN1)

1 Connect the 24V DC and 0V DC cables to CN1 (2 pin).

- Do not connect multiple power cables to one pole. Failure to follow this could result in electric shock, short circuit, and/or damage due to the capacity of connectors being exceeded. (Connector capacity: 16 A)
- Do not connect the 24V DC and 0V DC cables incorrectly.
- Do not connect cables when connectors are plugged in.

Power connector  
WAGO 231-302-026-000

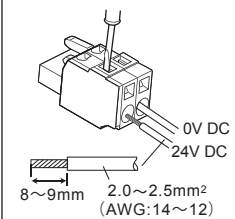

Control connector (CN4)

2 Connect each cable to CN4 (6 pin).  
\*Refer to the above, and perform wiring according to operation.

- Use the same voltage to be input to CN2#1 (MDR RUN/STOP) and CN2#2 (MDR rotation direction) as the power supply voltage. (Connector capacity: 4A)
- When connecting a relay coil, etc., to the remote output, use surge protector devices or add diode for surge protection. Using devices without surge protection measures could result in damage to the remote output terminal, if counter electromotive voltage is generated when switching the output signal.

Control connector  
WAGO 733-106

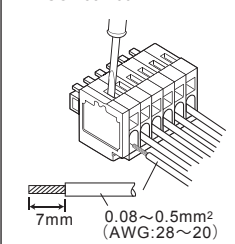

Connecting to driver cards

3 Connect the power connector (CN1), control connector (CN4), M1 MDR connector and M4 MDR connector to driver cards. Connect M1 to MotorA and M4 to MotorB

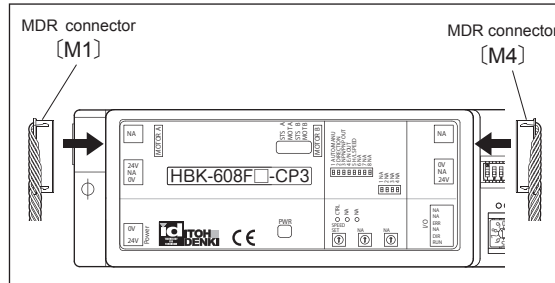

Safety precautions

Advance preparation

Product check

Structures

Installation/Wiring

Control/Operation

Maintenance/Inspection

Troubleshooting

Appendix

7. Installation/Wiring

M2 : For roller transfer

Wiring for CB-016

CB-016

**Connector descriptions**

CN1 (Power)	#2	0V
	#1	24V DC

		Functions	Detailed descriptions
CN2 (Control)	#5	Output	Motor pulse output
	#4	Output	Error signal output
	#3	Analog input	MDR external speed setting
	#2	Input	MDR rotation direction switching
	#1	Input	MDR RUN/STOP

Power connector (CN1)

**1** Connect the 24V DC and 0V DC cables to CN1 (2 pin).

- Do not connect multiple power cables to one pole. Failure to follow this could result in electric shock, short circuit, and/or damage due to the capacity of connectors being exceeded. (Connector capacity: 10 A)
- Do not connect the 24V DC and 0V DC cables incorrectly.
- Do not connect cables when connectors are plugged in.

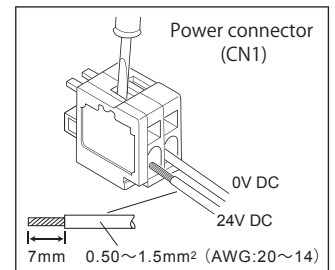

Control connector (CN2)

**2** Connect each cable to CN2 (5 pin).  
\* Refer to the above, and perform wiring according to operation.

- Use the same voltage to be input to CN2#1 (MDR RUN/STOP) and CN2#2 (MDR rotation direction) as the power supply voltage. (Connector capacity: 4A)
- When connecting a relay coil, etc., to the remote output, use surge protector devices or add diode for surge protection. Using devices without surge protection measures could result in damage to the remote output terminal, if counter electromotive voltage is generated when switching the output signal.

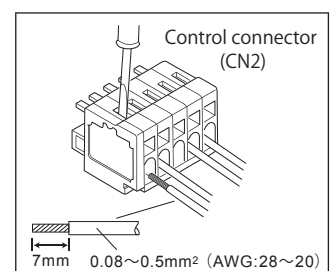

Connecting to driver cards

**3** Connect the power connector (CN1), control connector (CN2), and M2 MDR connector to driver cards.

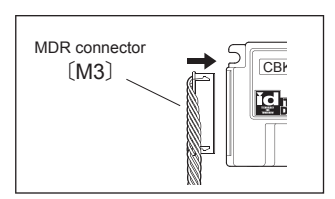

For more details on CB-016, please download the driver card user manual from our web page.

<http://itohdenki.co.jp/english/support/manual.html>

Safety precautions  
 Advance preparation  
 Product check  
 Structures  
 Installation/Wiring  
 Control/Operation  
 Maintenance/Inspection  
 Troubleshooting  
 Appendix

7. Installation/Wiring

M3 : For drive switching

Wiring for HBM-201

HBM-201

**■ Connector descriptions**

CN1 (Power)	#2	0V
	#1	24V DC

		Functions		Detailed descriptions	
CN2 (Control)	#5	Input	Carrier wheel surface switch input	<ul style="list-style-type: none"> <li>Carrier wheel and roller transfer surface are switched by inputting signal</li> <li>Teaching* settings can be performed when both #4 and #5 are ON</li> </ul>	
	#4	Input	Roller surface switch input		
	#3	—	Unused		
	#2	Output	Carrier wheel surface standby output	<ul style="list-style-type: none"> <li>Teaching* has not completed when both #1 and #2 are ON (when the power is turned on)</li> <li>Transfer surfaces are being switched, and teaching is in operation when both #1 and #2 are OFF</li> <li>Open collector output (Attach protection resistance so that the output is 25mA or less.)</li> </ul>	
	#1	Output	Roller surface standby output		

Power connector (CN1)

**1** Connect the 24V DC and 0V DC cables to CN1 (2 pin).



- Do not connect multiple power cables to one pole. Failure to follow this could result in electric shock, short circuit, and/or damage due to the capacity of connectors being exceeded. (Connector capacity: 10 A)
- Do not connect the 24V DC and 0V DC cables incorrectly.
- Do not connect cables when connectors are plugged in.

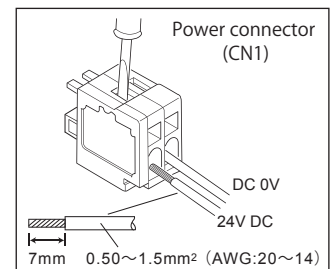

Control connector (CN2)

**2** Connect the above four cables.



- Use the same voltage to be input to CN2#1 as the power supply voltage. (Connector capacity: 4A)
- When connecting a relay coil, etc., to the remote output, use surge protector devices or add diode for surge protection. Using devices without surge protection measures could result in damage to the remote output terminal, if counter electromotive voltage is generated when switching the output signal.

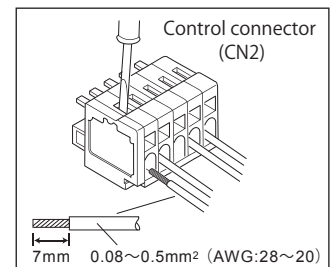

Connecting to driver cards

**3** Connect the power connector (CN1), control connector (CN2), and M3 MDR connector to driver cards.

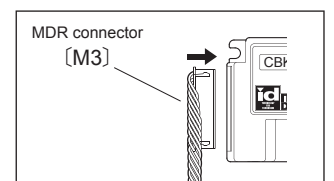

\* Teaching

Operation to perform the initial setting of the transfer surface position. Teaching must be performed after the power is turned on.

Term

7. Installation/Wiring

Setting driver cards

Verify setting of Driver as shown below.

Standard type

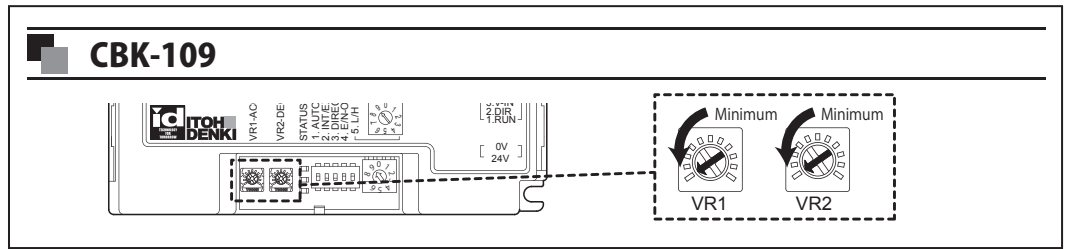

E1 type

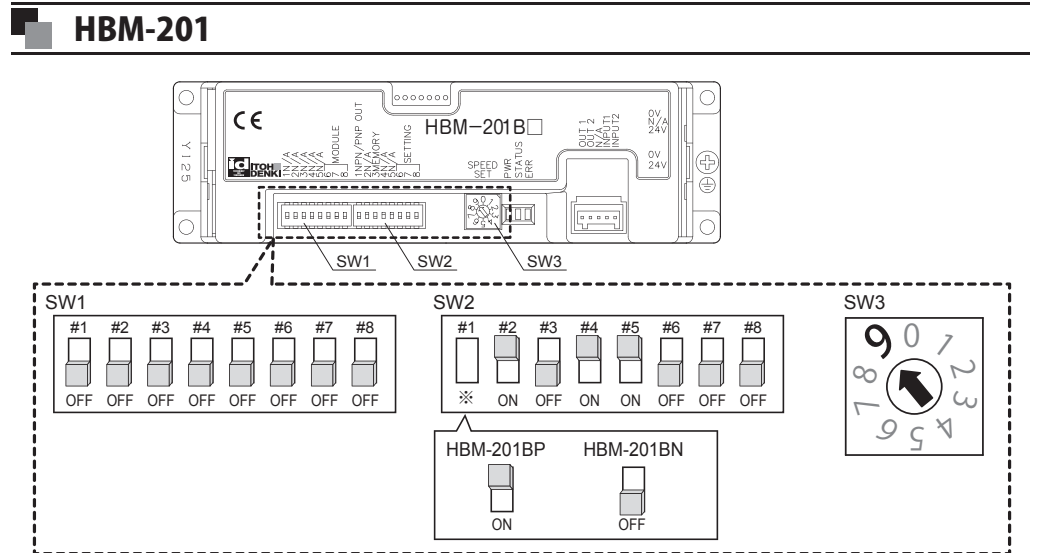
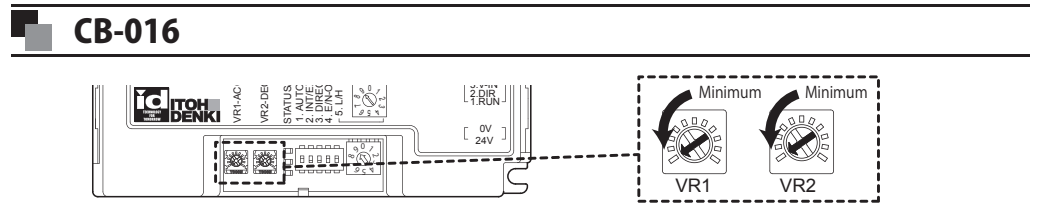
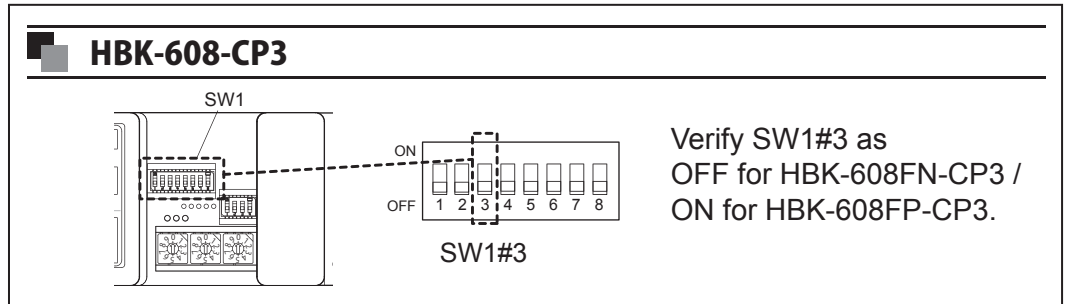

Safety precautions

Advance preparation

Product check

Structures

Installation/Wiring

Control/Operation

Maintenance/Inspection

Troubleshooting

Appendix

## 7. Installation/Wiring

### Connecting to power supply units

### Connecting signal cables of driver cards/sensors to PLCs

#### ■ Connecting to power supply units

The power is supplied to driver cards from the power connector (CN1). Connect customer-prepared power cables of zone and area sensors for loading and discharging.

#### ■ Connecting signal cables of driver cards/sensors to PLCs

Connect signal cables of driver cards to controllers, such as PLCs. Connect customer-prepared signal cables of zone and area sensors for loading and discharging.

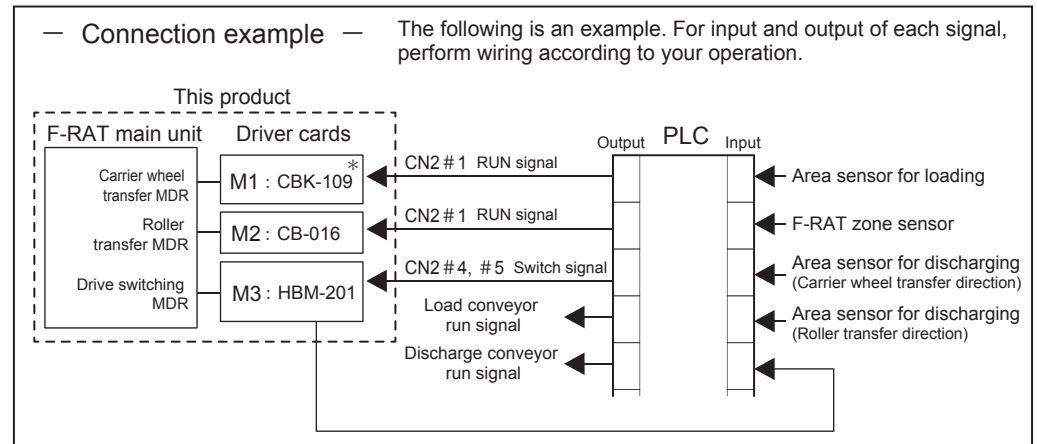

\* M1 and M4 of E1 type connect to HBK-608-CP3 instead.

# 8. Control/Operation

8-1. Basic operation	.....	47
8-2. Switching the transfer direction	.....	51
8-3. Changing the speed	.....	52
8-4. Switching the transfer surface	.....	55
8-5. About the initial position setting (teaching) of the transfer surface	.....	56
8-6. Program example	.....	57
8-7. What to do before operation	.....	58

8. Control/Operation

Device configuration image

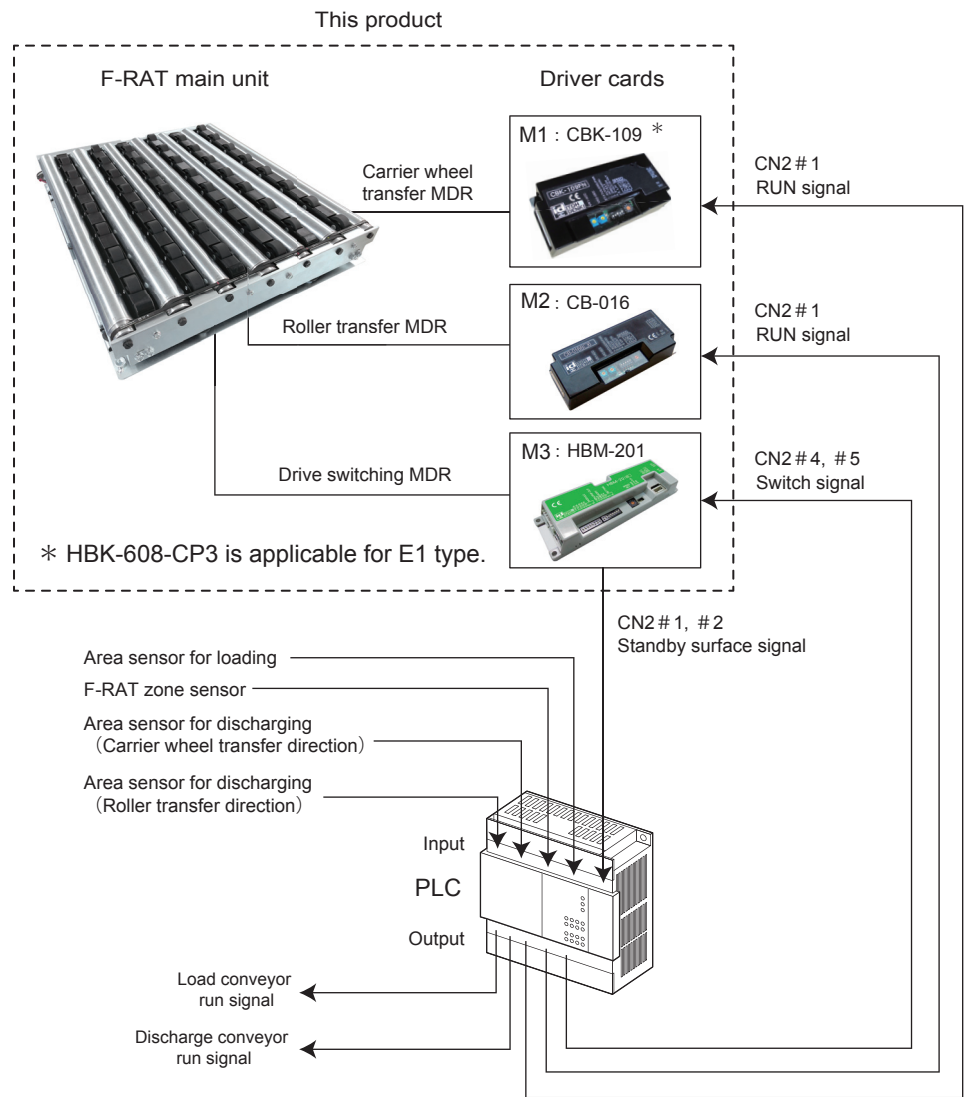

\* HBK-608-CP3 is applicable for E1 type.

Standard type

Label description	MDR code	Driver card
M1 *	Carrier wheel transfer MDR	CBK-109
M2 *	Roller transfer MDR	CB-016
M3 *	Drive switching MDR	HBM-201

E1 type

Label description	MDR code	Driver card
M1 *	Carrier wheel transfer MDR	HBK-608-CP3
M2 *	Roller transfer MDR	CB-016
M3 *	Drive switching MDR	HBM-201
M4 *	Carrier wheel transfer MDR	HBK-608-CP3

\* Refer to the labels for cables coming from the F-RAT main unit.

**Zone sensor**  
A sensor to detect the existence of trays within the zone

**Area sensor**  
A sensor to detect load and discharge of trays

Safety precautions  
Advance preparation  
Product check  
Structures  
Installation/Wiring  
Control/Operation  
Maintenance/Inspection  
Troubleshooting  
Appendix

8. Control/Operation

8-1.

Basic operation

Operation image

Turn on the power

Set the initial position of the transfer surface (Teaching)

Load

Switch the transfer surface to the diverting direction (Roller transfer → Carrier wheel transfer)

Discharge

Prepare reception (Transfer surface switch) (Carrier wheel transfer → Roller transfer)



About control

■ F-RAT uses MDR for each of carrier wheel transfer, roller transfer, and transfer surface switch (3 axes in total). Make sure to control to allow each axis to run independently.

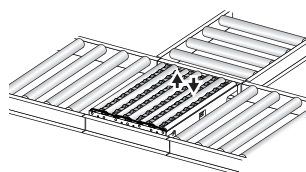
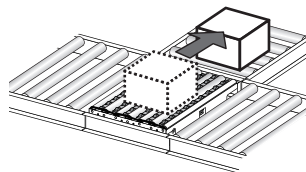
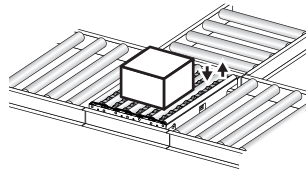
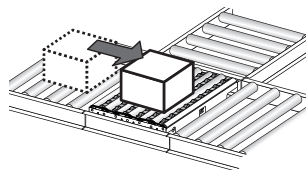
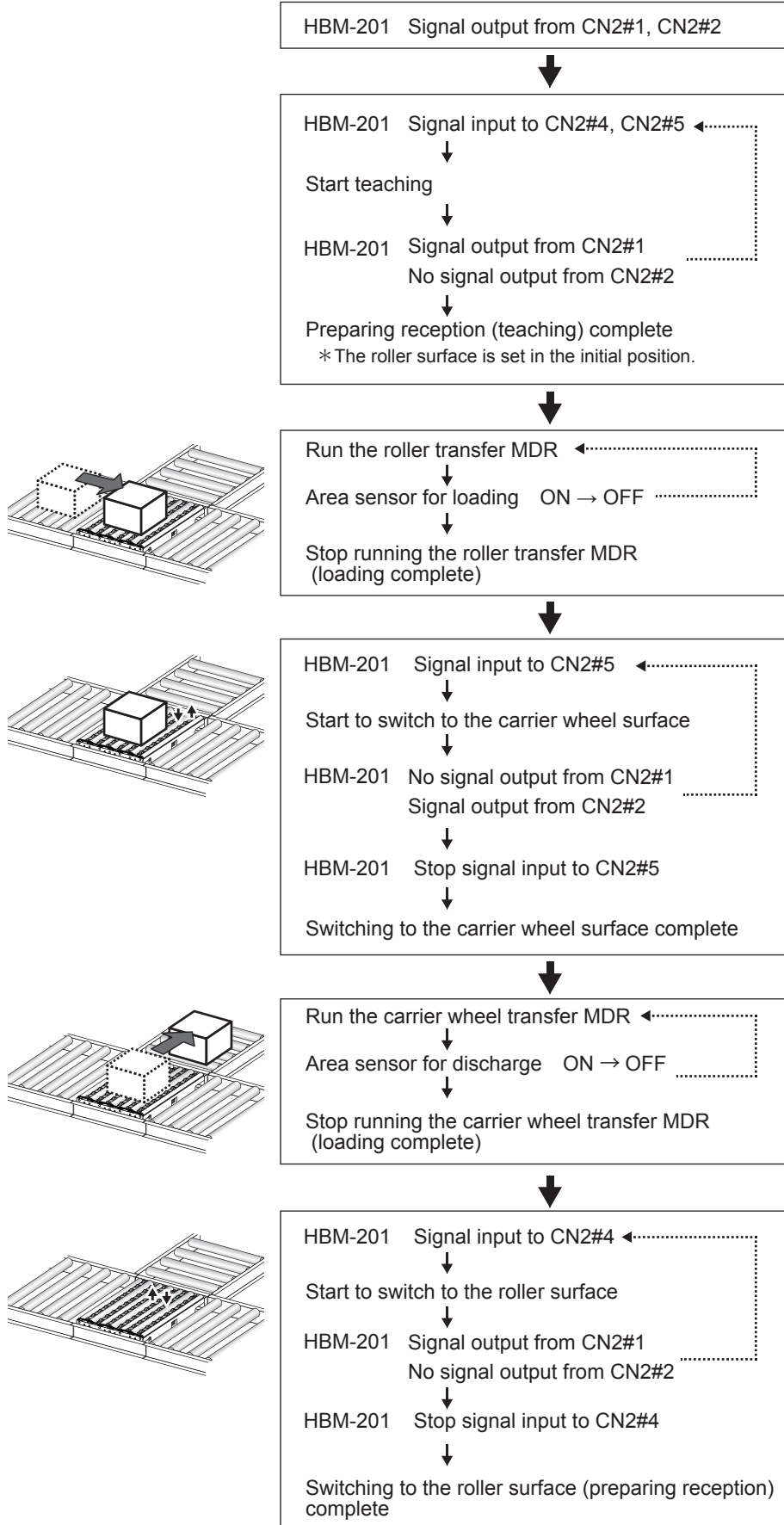

# 8. Control/Operation

## 8-1. Basic operation

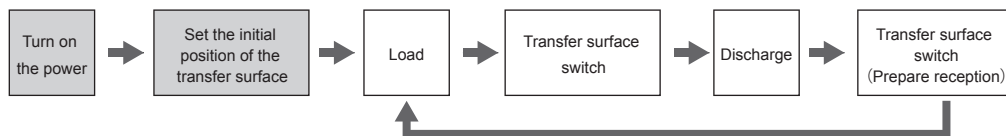

The following operation is for when the rotation direction setting SW1#3 for CB-016 and CBK-109 is OFF (factory setting). Loading and discharging directions will be changed depending on the SW1#3 setting and signal input to CN2.  
 [Refer to 8-2. Switching the transfer direction on P.46.]

Transfer flow chart (when using the roller for loading, and carrier wheel for discharging)

	F-RAT operation	Signal input/output																
<p>Turn on the power</p>		<p>Turn 24V DC on</p> <p>HBM-201 Signal output from CN2#1, CN2#2</p>	<p>After the power is turned on, the LED display are indicated as below.</p> <table border="1"> <tr> <td><b>CBK-109*1</b></td> <td><b>CB-016</b></td> <td><b>HBM-201</b></td> </tr> <tr> <td></td> <td></td> <td></td> </tr> <tr> <td>PWR (Green) ON</td> <td>ERR (Red) OFF</td> <td>PWR (Green) 1Hz blinking</td> </tr> <tr> <td></td> <td></td> <td>STATUS (Orange) OFF</td> </tr> <tr> <td>STATUS (Orange) OFF</td> <td></td> <td>ERR (Red) OFF</td> </tr> </table>	<b>CBK-109*1</b>	<b>CB-016</b>	<b>HBM-201</b>				PWR (Green) ON	ERR (Red) OFF	PWR (Green) 1Hz blinking			STATUS (Orange) OFF	STATUS (Orange) OFF		ERR (Red) OFF
<b>CBK-109*1</b>	<b>CB-016</b>	<b>HBM-201</b>																
PWR (Green) ON	ERR (Red) OFF	PWR (Green) 1Hz blinking																
		STATUS (Orange) OFF																
STATUS (Orange) OFF		ERR (Red) OFF																
<p>Set the initial position of the transfer surface (Teaching)</p>	<p>Start the transfer surface switch operation</p> <p>Stop the transfer surface switch operation (Transfer surface setting complete)                      * The roller surface is set in the initial position.</p>	<p>HBM-201 Signal input to CN2#4, CN2#5</p> <p>HBM-201 Stop signal output from CN2#1, CN2#2</p> <p>HBM-201 Signal output from CN2#1</p> <p>HBM-201 Stop signal input to CN2#4, CN2#5</p>	<p>When preparing reception is complete, the roller surface is set on standby.</p> <div style="border: 1px dashed black; padding: 5px;"> <p> <b>Teaching</b>                      Operation to perform the initial setting of the transfer surface position.                      Teaching must be performed when the power is turned on.</p> </div>															

\*1 HBK-608-CP3 is applicable for E1 type

Safety precautions  
 Advance preparation  
 Product check  
 Structures  
 Installation/Wiring  
 Control/Operation  
 Maintenance/Inspection  
 Troubleshooting  
 Appendix

8. Control/Operation

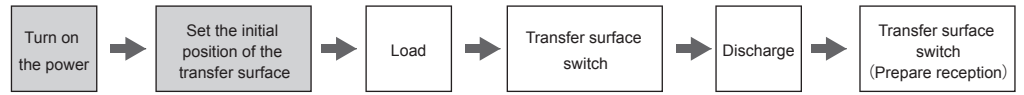

Load

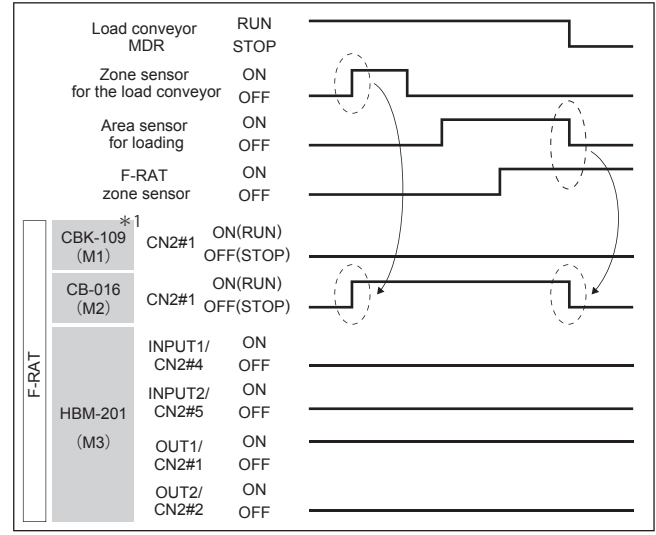
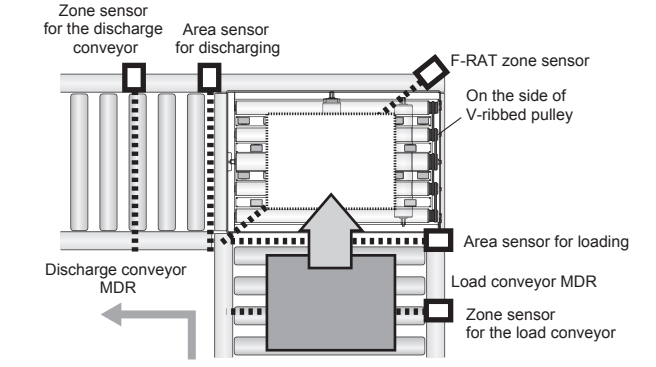
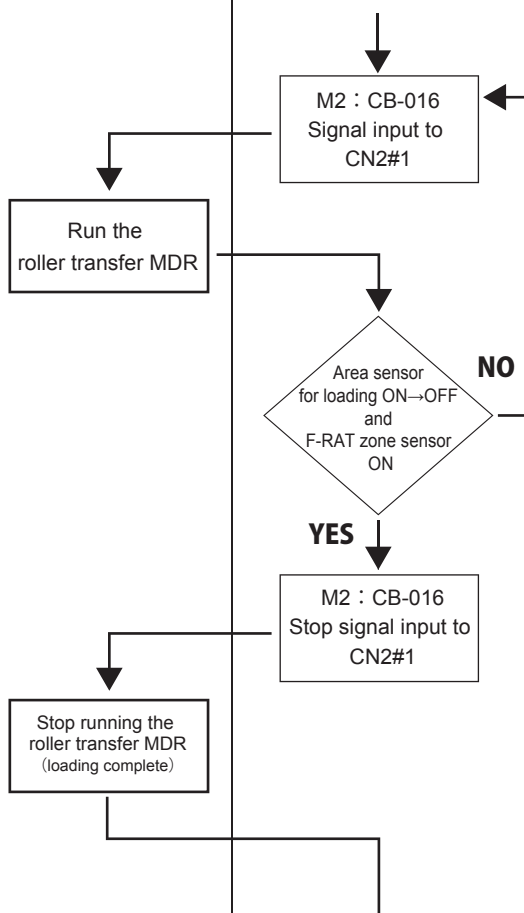

Transfer surface switch

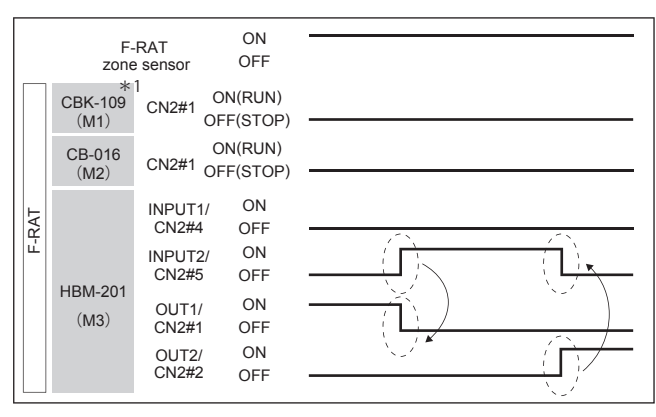
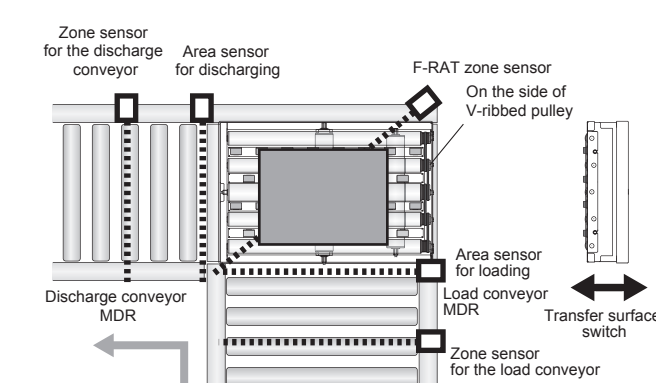
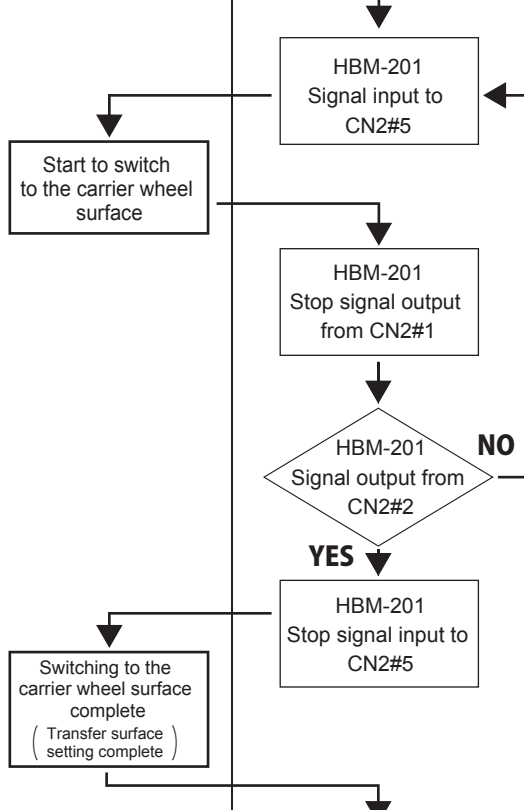

\*1 HBK-608-CP3 (M1, M4) is for E1 type.

Safety precautions  
Advance preparation  
Product check  
Structures  
Installation/Wiring  
Control/Operation  
Maintenance/Inspection  
Troubleshooting  
Appendix

8. Control/Operation

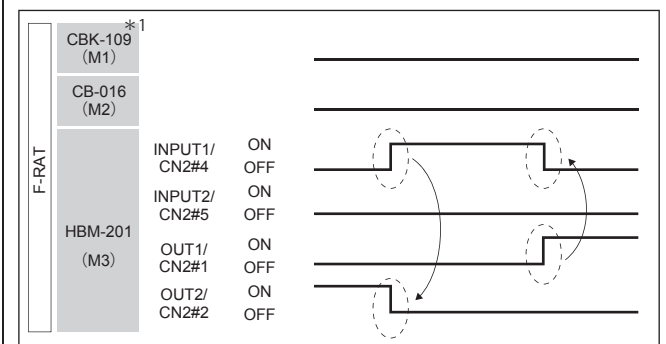
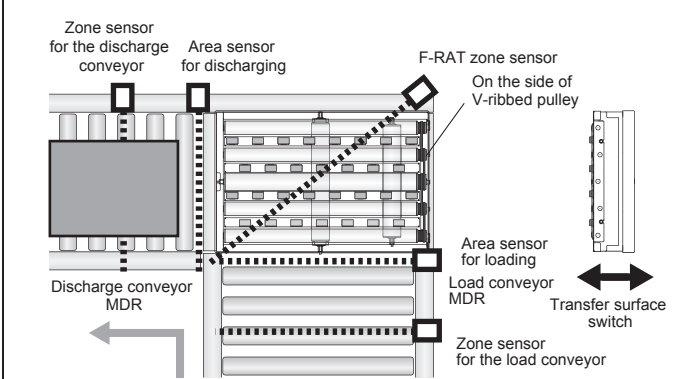
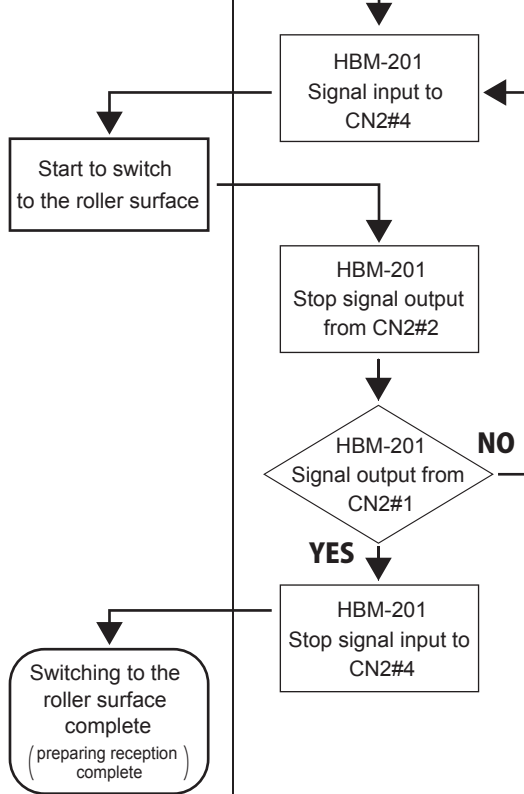
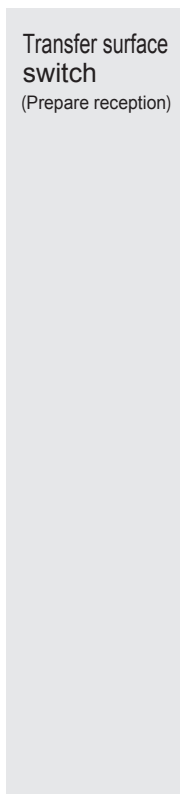
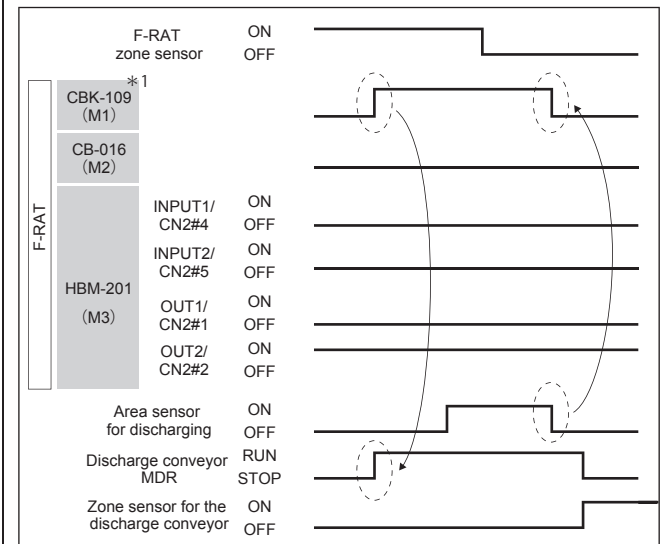
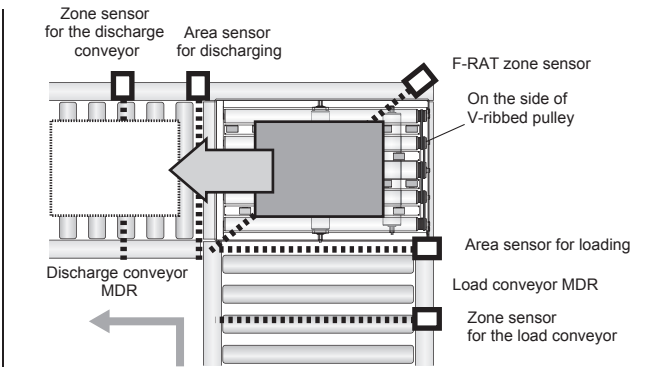
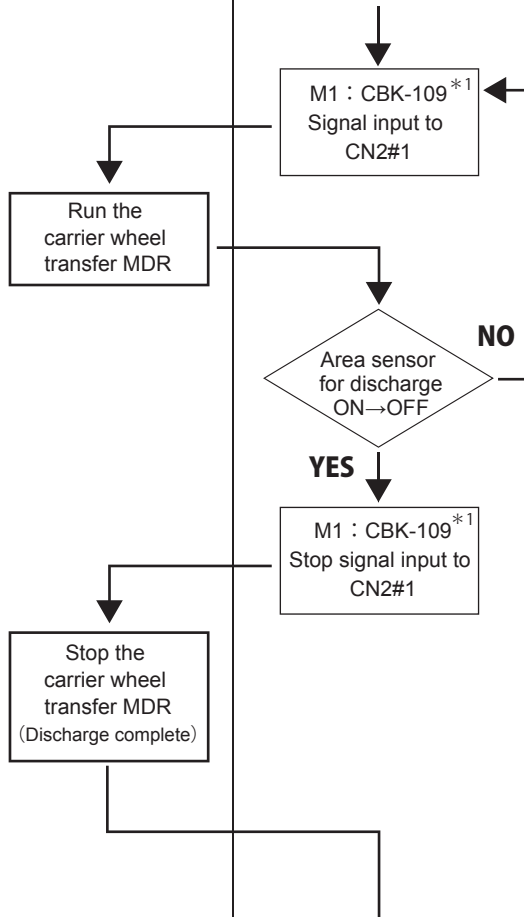
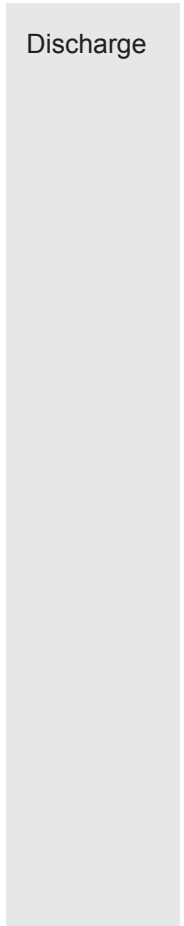
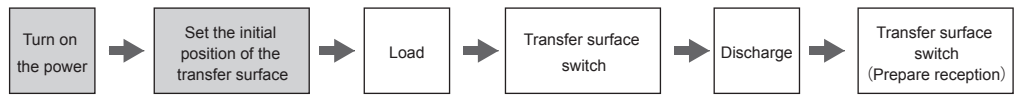

\*1 HBK-608-CP3 (M1, M4) is for E1 type.

Safety precautions  
Advance preparation  
Product check  
Structures  
Installation/Wiring  
Control/Operation  
Maintenance/Inspection  
Troubleshooting  
Appendix

8. Control/Operation

8-2.

Switching the transfer direction

Carrier wheel transfer

**Switching the transfer direction**

The transfer direction can be set by DIP-SW on the driver card, and signal input.

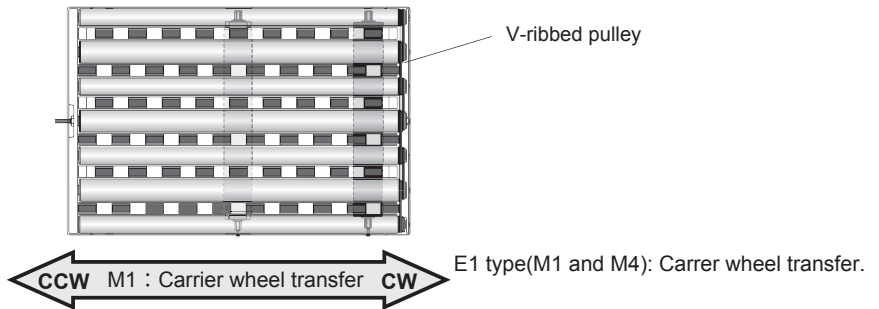

Standard type

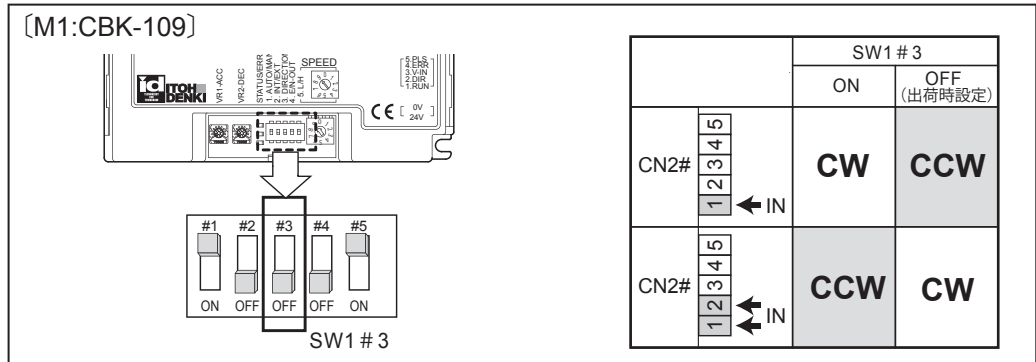

E1 type

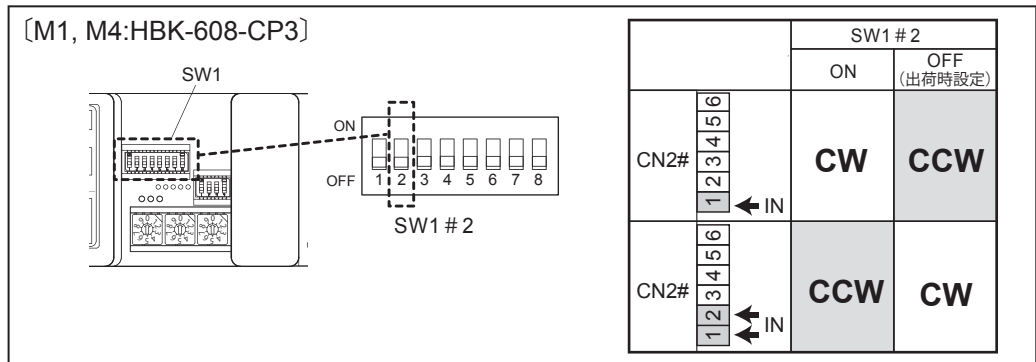

Roller transfer

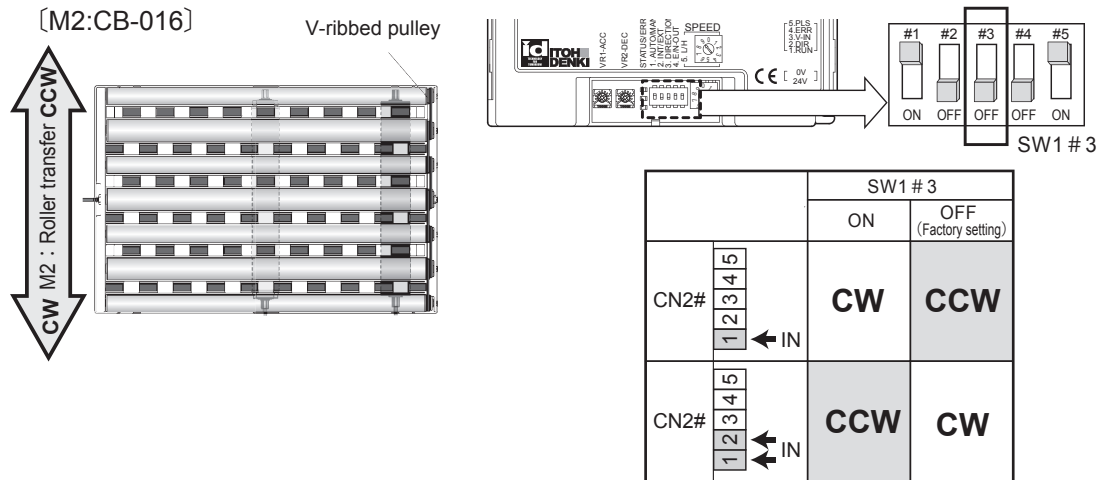

Transfer/Stop in the CW direction <sup>(note)</sup> by inputting signal

note) In case CBK-109/CB-016  
SW1#3 is OFF or HBK-608-CP3  
SW1#2 is OFF.

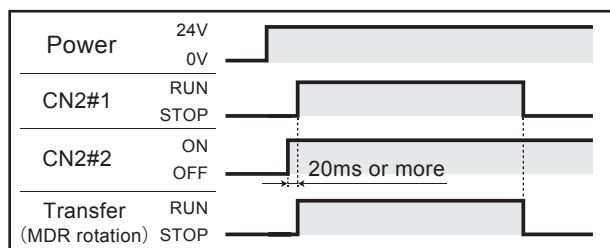

8-3.

Changing the transfer speed

Standard type

**Changing the transfer speed**

[M1:CBK-109]

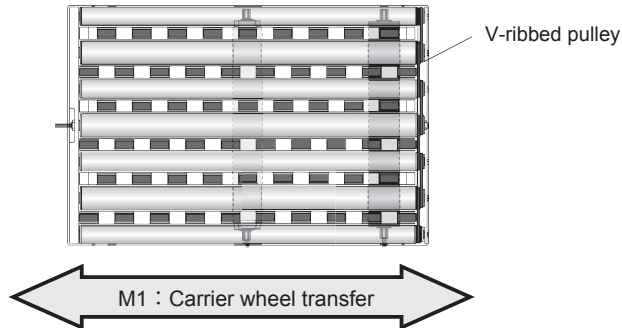

**Internal speed setting**

- 1** Set SW1#2 to OFF.
- 2** Set SW1#5 and SW5.

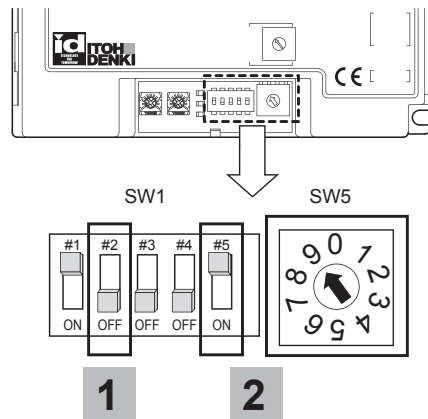

**External speed setting**

- 1** Turn SW1#2 ON.
- 2** Input the voltage to CN2#3.

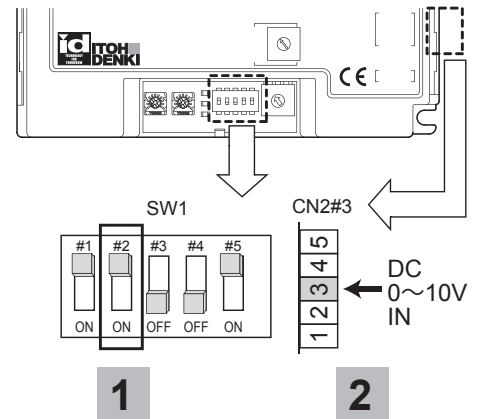

Speed chart (m/min)

[M1 : Carrier wheel speed]

Speed accuracy: ±3%

SW5	SW1#5 : ON										SW1#5 : OFF									
	9	8	7	6	5	4	3	2	1	0	9	8	7	6	5	4	3	2	1	0
Setting	61.6	56.5	53.9	51.4	48.8	46.2	41.1	38.5	36.0	33.4	30.8	28.2	25.7	23.1	20.5	18.0	15.4	12.8	10.3	7.7
External voltage Input (V)	9.6 9.9	9.1 9.4	8.6 8.9	8.1 8.4	7.6 7.9	7.1 7.4	6.6 6.9	6.1 6.4	5.6 5.9	5.1 5.4	4.6 4.9	4.1 4.4	3.6 3.9	3.1 3.4	2.6 2.9	2.1 2.4	1.6 1.9	1.1 1.4	0.6 0.9	0.1 0.4

: Factory setting



■ The speed can be changed even during transfer (when RUN signal is being input).



- Values in “Setting” indicate the speed when trays are not placed on carrier wheels and rollers.
- Described speed is an approximate speed around 30 minutes after start-up. During operation, the rising time to the setting speed may vary depending on ambient temperature. Perform running operation thoroughly.
- Values described above may differ from the actual transfer speed depending on the weight, material, bottom surface, and/or shape of trays, as well as ambient temperature.

8. Control/Operation

E1 type 

[M1, M4 : HBK-608-CP3]

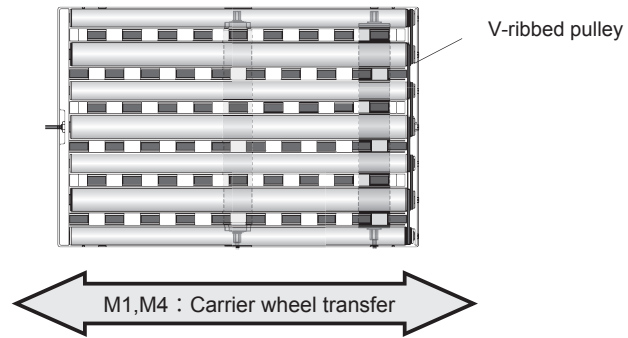

Set SW1#5 and SW2.

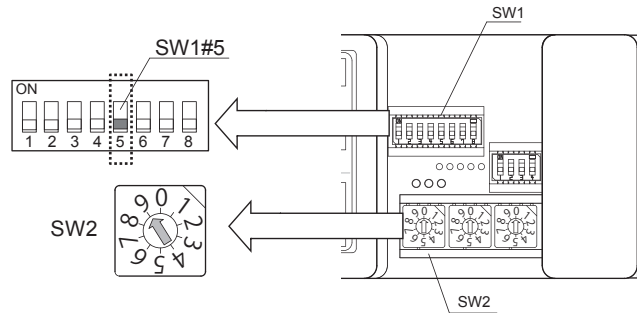

Speed chart  
(m/min)

[M1, M4 : Carrier wheel speed]

Speed accuracy: ±3%

SW1 #5	ON										OFF									
	9	8	7	6	5	4	3	2	1	0	9	8	7	6	5	4	3	2	1	0
Setting	61.6	56.5	53.9	51.4	48.8	46.2	41.1	38.5	36.0	33.4	30.8	28.2	25.7	23.1	20.5	18.0	15.4	12.8	10.3	9.0

 : Factory setting



■ The speed can be changed even during transfer (when RUN signal is being input).



■ Values in "Setting" indicate the speed when trays are not placed on carrier wheels and rollers.

■ Described speed is an approximate speed around 30 minutes after startup. During operation, the rising time to the setting speed may vary depending on ambient temperature. Perform running operation thoroughly.

■ Values described above may differ from the actual transfer speed depending on the weight, material, bottom surface, and/or shape of trays, as well as ambient temperature.

8. Control/Operation

[M2:CB-016]

There are two types of settings to change speed: the internal speed setting to change the speed by switches on the driver card, and the external speed setting to change the speed by inputting the analog voltage to CN2#3.

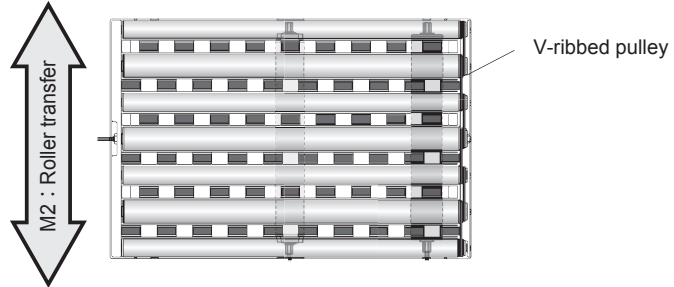

Internal speed setting

- 1 Set SW1#2 to OFF.
- 2 Set SW1#5 and SW5.

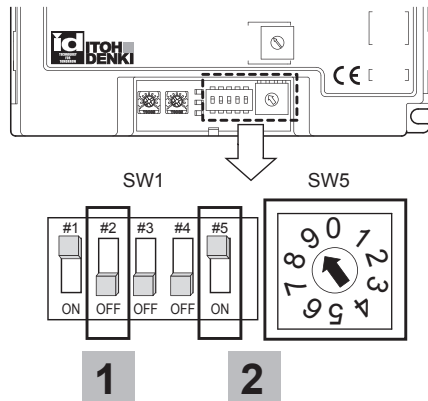

External speed setting

- 1 Turn SW1#2 ON.
- 2 Input the voltage to CN2#3.

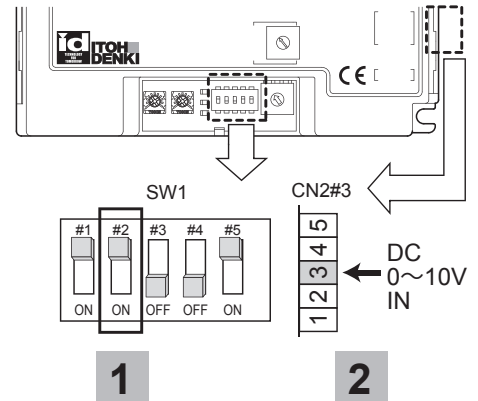

Speed chart (m/min)

[M2 : Roller speed]

Speed accuracy: ±3%

SW5	SW1#5 : ON										SW1#5 : OFF									
	9	8	7	6	5	4	3	2	1	0	9	8	7	6	5	4	3	2	1	0
Nominal speed 17 m/min type	Setting 16.9	15.5	14.8	14.1	13.4	12.7	11.2	10.5	9.8	9.1	8.4	7.7	7.0	6.3	5.6	4.9	4.2	3.5	2.8	2.1
Nominal speed 60 m/min type	Setting 60.0	55.0	52.5	50.0	47.5	45.0	40.0	37.5	35.0	32.5	30.0	27.5	25.0	22.5	20.0	17.5	15.0	12.5	10.0	7.5
External voltage Input (V)	9.6 9.9	9.1 9.4	8.6 8.9	8.1 8.4	7.6 7.4	7.1 7.4	6.6 6.9	6.1 6.4	5.6 5.9	5.1 5.4	4.6 4.9	4.1 4.4	3.6 3.9	3.1 3.4	2.6 2.9	2.1 2.4	1.6 1.9	1.1 1.4	0.6 0.9	0.1 0.4

■ : Factory setting



■ The speed can be changed even during transfer (when RUN signal is being input).



- Values in "Setting" indicate the speed when trays are not placed on carrier wheels and rollers.
- Described speed is an approximate speed around 30 minutes after startup. During operation, the rising time to the setting speed may vary depending on ambient temperature. Perform running operation thoroughly.
- Values described above may differ from the actual transfer speed depending on the weight, material, bottom surface, and/or shape of trays, as well as ambient temperature.

8. Control/Operation

8-4.

Switching the transfer surface

[M3:HBM-201]

Roller transfer →  
Carrier wheel transfer

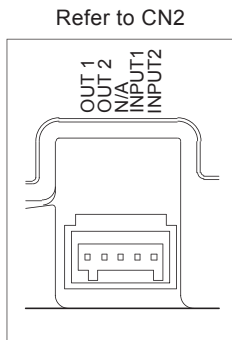

Carrier wheel transfer →  
Roller transfer

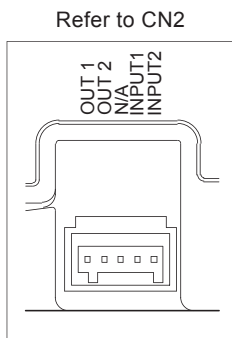

Switching the transfer surface

The transfer surface can be switched by inputting the signal to CN2#4 and CN2#5.



After the initial position setting (teaching) of the transfer surface, the roller surface is put on standby. To put the carrier wheel surface on standby (use it for reception), the transfer surface needs to be changed using the signal input. Refer to 8-5. About the initial position setting (teaching) of the transfer surface (P.50)

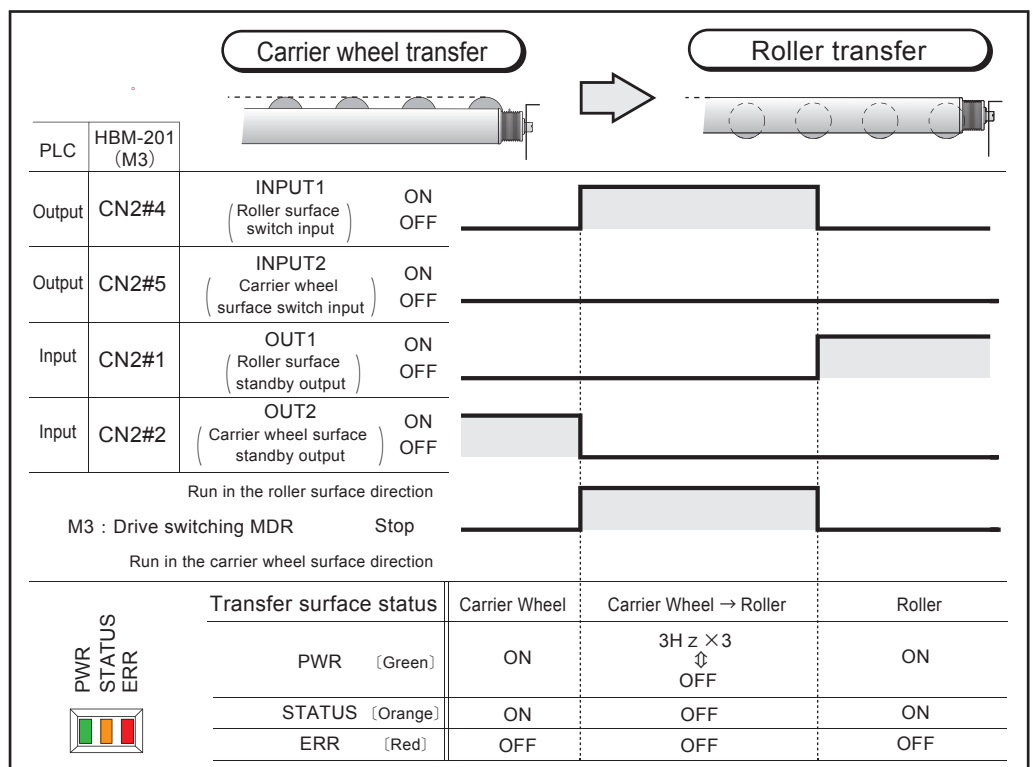
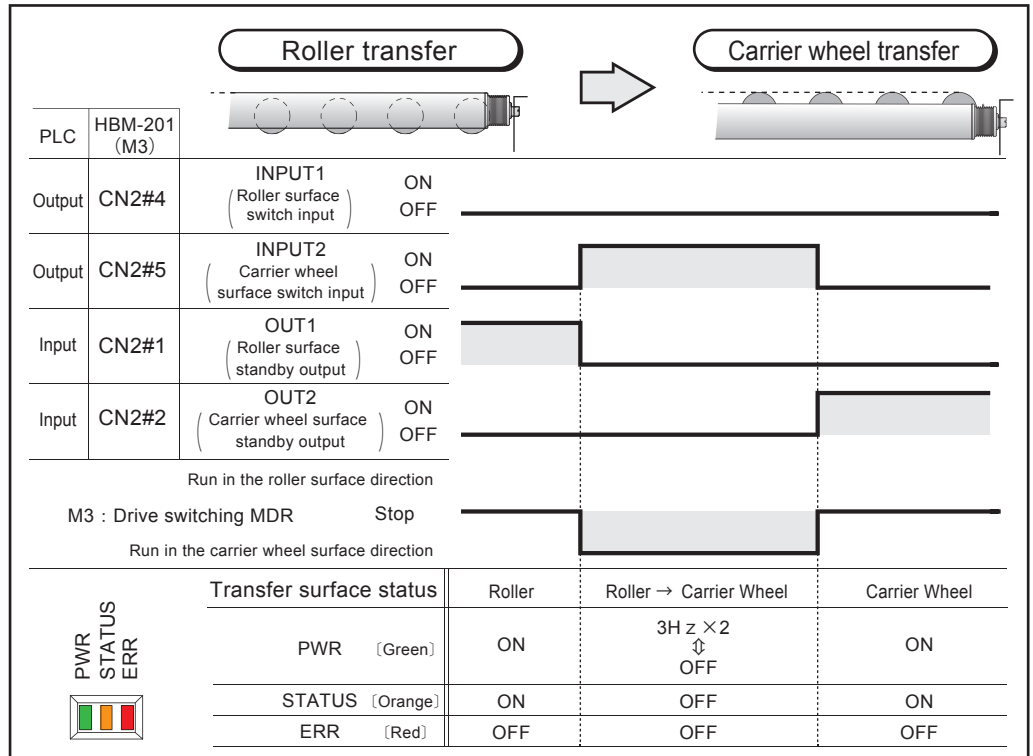

If the signal input stops when the transfer surface is being switched, operation will be interrupted, and the signal output from both CN2#1 and #2 will stop. When inputting the signal again, operation restarts.

8. Control/Operation

8-5.

About the initial position setting (teaching) of the transfer surface

[M3:HBM-201]

Teaching operation

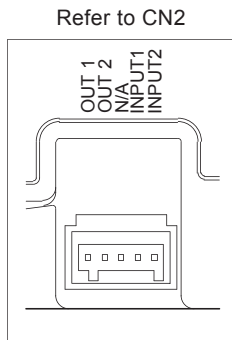

About the initial position setting (teaching) of the transfer surface

The initial position setting (teaching) of the transfer surface is necessary to set the transfer surface after the power is turned on.



- If teaching has not been set, the transfer surface cannot be switched.
- During teaching operation, do not load trays on the F-RAT.
- When teaching fails, both CN2#1(OUT1)(roller surface status output) and CN2#2(OUT2)(carrier wheel status output) are turned ON, which is the same status as when the power is turned on. In such cases, perform teaching operation again.

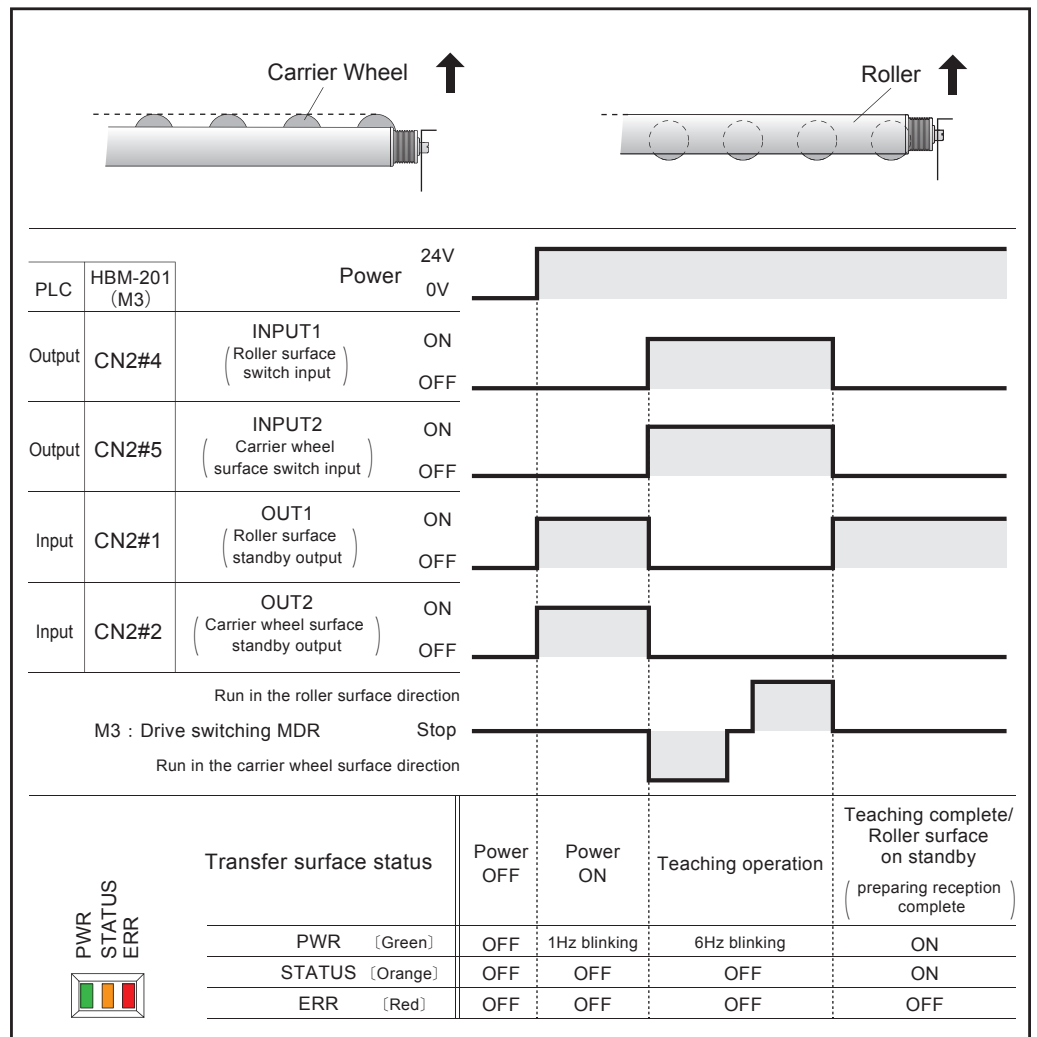

Teaching

Operation to perform the initial setting of the transfer surface position. After the power is turned on, perform teaching by inputting signal from the driver card.

Term

8. Control/Operation

8-6.

Program example

Operation by loading through roller transfer and discharging through carrier wheel transfer

Basic operation (example)

Time chart example

Program example



Do not load trays from the roller transfer MDR direction while the carrier wheel status (signal from CN2#2 on HBM-201) is output. Failure to follow this could result in damage to trays, and malfunction.

The following time chart is an example.

When in use, control the number of sensors, and/or determine how to place/control sensors depending on your operation.

When loading through roller transfer, discharging through carrier wheel transfer, and standing ready on the roller surface after discharge ends

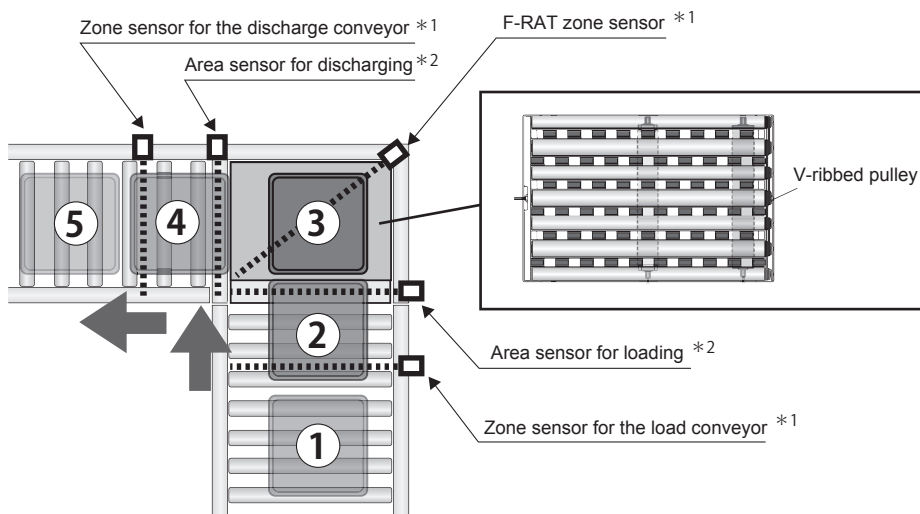

PLC	Tray position	①	②	③	④	⑤
Input	Zone sensor for the load conveyor	ON	ON	ON	ON	ON
		OFF	OFF	OFF	OFF	OFF
Input	Area sensor for loading	ON	ON	ON	ON	ON
		OFF	OFF	OFF	OFF	OFF
Input	F-RAT zone sensor	ON	ON	ON	ON	ON
		OFF	OFF	OFF	OFF	OFF
Input	Area sensor for discharging (Carrier wheel discharge direction)	ON	ON	ON	ON	ON
		OFF	OFF	OFF	OFF	OFF
Output	Roller transfer MDR (M2)	RUN	RUN	RUN	RUN	RUN
		STOP	STOP	STOP	STOP	STOP
Output	Carrier wheel transfer MDR (M1)*1	RUN	RUN	RUN	RUN	RUN
		STOP	STOP	STOP	STOP	STOP
Output	Drive switching MDR (M3)	INPUT2 Carrier wheel surface switch input	ON	ON	ON	ON
		OFF	OFF	OFF	OFF	
		INPUT1 Roller surface switch input	ON	ON	ON	ON
		OFF	OFF	OFF	OFF	
Input	OUT1 (Roller surface standby output)	ON	ON	ON	ON	ON
		OFF	OFF	OFF	OFF	
Input	OUT2 (Carrier wheel surface standby output)	ON	ON	ON	ON	ON
		OFF	OFF	OFF	OFF	

It is assumed that switches on CBK-109 and CB-016 are used based on the initial settings.  
\* 1 M1 and M4 are applicable for E1 type.



Term

- \*1 Zone sensor  
A sensor to detect the existence of trays within the zone
- \*2 Area sensor  
A sensor to detect load and discharge of trays

8. Control/Operation



8-7. What to do before operation

Start-up inspection

To prevent accidents and/or damage to devices during operation, refer to the below before operation, and check the safety.

**Items to check before turning on the power**



Turn off the power of all connected devices, and perform the following inspection, taking necessary measures.

-  Turn off the power, wait a sufficient amount of time, and discharge electricity inside the DC power supply equipment.
-  Post warning labels so as to prevent unauthorized persons from turning on the power.

Parts to be inspected	Inspection items	Description of measures
Secured positions of the F-RAT main unit	Screw looseness	Re-tighten screws
Driver card	Damage, deformation	Contact the supplier
	Screw looseness on secured positions	Re-tighten screws
	Mounting failure for driver cards and connectors	Correctly mount connectors
	Damage to cables/Wiring failure	Perform wiring correctly
Idler for roller transfer	External abnormalities, such as scratches or breakage	Refer to P.66 <u>9-2. Before replacement work</u>
Roller transfer MDR	External abnormalities, such as scratches, dents, or breakage	
Roller drive belt for roller transfer	Cracks, looseness, wear on the surface	
Carrier wheel	Cracks, wear on the surface	
Others	Parts deformation, damage	Contact the supplier
	Cable damage	

**Items to check after turning on the power**

Manually input the signal to driver cards according to inspection contents.

-  Perform inspection after completing measures to prevent fingers from getting stuck and/or caught in rollers during transfer switching, and/or transfer operation.
-  Take safety measures, such as getting ready to shut off the power in the event that something should happen.

Parts to be inspected	Inspection items	Description of measures
Driver card	Error check with LED display <Normal LED display after the power is turned on> Judged as errors if the LED display is other than that below.  <div style="display: flex; align-items: center;"> <div style="margin-right: 10px;"> <div style="border: 1px solid black; border-radius: 5px; padding: 2px 5px; display: inline-block;">CBK-109 *</div>  <div style="border: 1px solid black; border-radius: 5px; padding: 2px 5px; display: inline-block;">CB-016</div>  <div style="border: 1px solid black; border-radius: 5px; padding: 2px 5px; display: inline-block;">HBM-201</div> </div> <div style="font-size: 2em; vertical-align: middle;">}</div> <div>                     PWR (Green) ON                       ERR (Red) OFF                 </div> </div>	Check error contents, and eliminate the causes.  * For driver card LED display and error countermeasures, refer to <u>9-1. Driver card LED display and error countermeasures</u> (P.61).
Idler for roller transfer	Abnormal sound ----- Rotation failure	Refer to P.66 <u>9-2. Before replacement work</u>
Roller transfer MDR	Abnormal sound ----- Decrease from the specified speed ----- Abnormal temperature rise	
Carrier wheel transfer MDR	Abnormal sound ----- Decrease from the specified speed ----- Abnormal temperature rise (Check ERR LED on driver cards)	Contact the supplier
Drive switching MDR	Abnormal sound ----- Abnormal temperature rise (Check ERR LED on driver cards)	
Others	Leakage from equipment	Check grounding on equipment, perform grounding

\* HBK-608-CP3 is applicable for E1 type.

Safety precautions  
Advance preparation  
Product check  
Structures  
Installation/Wiring  
Control/Operation  
Maintenance/Inspection  
Troubleshooting  
Appendix

## 8. Control/Operation

### Trial run

#### ■ Items to check before the trial run

Check below before the trial run.

- When the roller transfer MDR and/or idlers have been replaced, check that the drive belts have been mounted in the correct groove positions.
- Check all parts are installed.

#### ■ Performing the trial run

When the start-up inspection has finished, perform the trial run with careful attention to the following points, and check that operation is correctly performed.



- Prevent other devices around the product from operating.  
Other devices incorporated in the system, such as conveyor lines, could create dangerous situations, since trays may start to flow from upstream when the trial run is driven.  
Check carefully that other elements in the system will not operate when the product starts running.
- Make sure to check that wiring, driver card settings, and PLC settings have been carried out correctly before the trial run.
- During operation, the transfer speed may not reach the specified value depending on ambient temperature.  
When the carrier wheel cassette has been replaced, perform running operation thoroughly to eliminate any bends from belts.

# 9. Maintenance/Inspection

9-1. Driver card LED display and error countermeasures	.....	61
9-2. Before replacement work	.....	66
9-3. Replacement of MDR for roller transfer/idlers/roller drive belts	.....	68
9-4. Replacement of the carrier wheel cassette	.....	73

## 9. Maintenance/Inspection

### 9-1. Driver card LED display and error countermeasures

Checking the driver card status

Standard type 

LED display explanation

If errors occur with this product, identify the cause of errors, and perform recovery work.

Identify the cause of errors by checking LEDs and error signal output on driver cards, and restore the product.

[CBK-109] For carrier wheel transfer

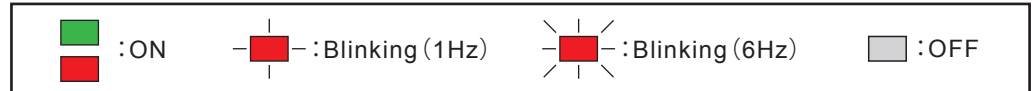







Errors can be checked by PWR (Green), ERR (Red), and signals from CN2#4.

-  When error signals have been released by CN2#1 (RUN / STOP), the F-RAT instantly starts up when RUN is input.
- When the power supply voltage becomes insufficient, operation may be disabled, or an unexpected operation may occur.
- To restart the F-RAT, switch the ON → OFF → ON / OFF → ON → OFF / RUN → STOP → RUN signals at intervals of 100 ms or more.

Error details

 : Manual recovery setting (SW1#1 ON) /  : Automatic recovery setting (SW1#1 OFF <factory setting>)

PWR (Green) ERR (Red)	CN2#4 (Error signal)		Causes	How to release error signals	Recovery operation
	SW1#4 OFF	SW1#4 ON			
	Output	Open	(Normal operation)	—	
	Open	Open	No power supply	Supply 24V DC	Refer to P.35 7-3. Wiring
	Open	Output	Damage to driver cards	Turn off the power, and replace the driver card	Refer to P.33, 35 7-2. Installation 7-3. Wiring
 	Open	Output	Thermal error Thermal protection has worked due to a temperature rise of driver cards or MDR	When one minute has elapsed after decreasing to the recovery temperature, the error signal is released, and the unit starts up instantly After decreasing to the recovery temperature, release the error signal, and start up the unit by RUN→STOP→RUN on CN2#1  After decreasing to the recovery temperature, switch ON→OFF→ON or OFF→ON→OFF on CN2#2 Start up the unit by RUN→STOP→RUN on CN2#1 The unit starts up within 1min  After decreasing to the recovery temperature, release the error signal, and start up the unit by RUN→STOP→RUN on CN2#1  After decreasing to the recovery temperature, switch ON→OFF→ON or OFF→ON→OFF on CN2#2 Start up the unit by RUN→STOP→RUN on CN2#1	
 	Open	Output	Connector disconnected	Turn off the power, and connect the connector	Refer to P.35 7-3. Wiring
 	Open	Output	MDR disconnection	Turn off the power, and replace the MDR	Refer to P.58 9-2. Before replacement work
 	Open	Output	Lock error MDR has been locked, and 0.5sec have elapsed	When 4sec or more have elapsed after an error occurs, release the error signal, and start up the unit by RUN→STOP→RUN on CN2#1 When 4sec or more have elapsed after an error occurs, switch ON→OFF→ON or OFF→ON→OFF on CN2#2	Start up the unit by RUN→STOP→RUN on CN2#1
 	Open	Output	Low voltage error Power supply voltage has been 15V or less for 1sec, or decreases to 15V or less 5 times within 500ms	 Secure the power supply voltage of 18V or more After securing the power supply voltage of 18V or more, release the error signal, and start up the unit by RUN→STOP→RUN on CN2#1  After securing the power supply voltage of 18V or more, switch ON→OFF→ON or OFF→ON→OFF on CN2#2	The unit starts up instantly Start up the unit by RUN→STOP→RUN on CN2#1
 	Open	Output	Back EMF error Voltage applied to the MDR has been 40V or more for 2sec, or has been 60V or more for 0.1sec *This error may occur when the MDR has rotated at speeds faster than the setting speed.	 Voltage applied to MDR has been 30V or less for 1sec After voltage applied to MDR has been 30V or less for 1sec, release the error signal, and start up the unit by RUN→STOP→RUN on CN2#1  After voltage applied to MDR has been 30V or less for 1sec, switch ON→OFF→ON or OFF→ON→OFF on CN2#2	The unit starts up instantly Start up the unit by RUN→STOP→RUN on CN2#1
 	Open	Output	A current of 7A or more flows in the MDR	No error signal	—

Errors will be also released when the power is OFF (for two seconds or more).

Safety precautions

Advance preparation

Product check

Structures

Installation/Wiring

Control/Operation

Maintenance/Inspection

Troubleshooting

Appendix

9. Maintenance/Inspection

E1 type 

[HBK-608-CP3] For carrier wheel transfer

Indicates status by LED

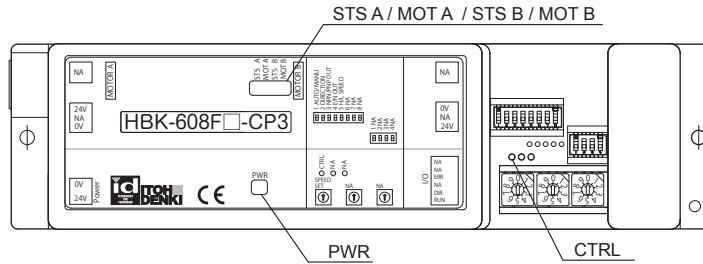

LED Indication

LED		LED condition			Status
		Green	Red	Orange	
PWR CTRL	Motor power LED	ON	—	—	Power ON
		OFF	—	—	Power OFF
MOT A	MOTOR A LED	ON	—	—	STANDBY
		OFF	—	—	*
MOT B	MOTOR B LED	ON	—	—	STANDBY
		OFF	—	—	*
STS A	Motor A	OFF	OFF	—	normal
		ON	OFF	—	Motor A Run
		OFF	Blinks (6Hz)	—	Low voltage / Fuse blown
		OFF	Blinks (1Hz)	—	Motor A unplugged
		ON	Blinks (1Hz)	—	Motor stall error
		OFF	ON	—	thermister error
		ON	Blinks (6Hz×2⇔1.7sec)	—	back EMF error
STS B	Motor B	OFF	OFF	—	normal
		ON	OFF	—	Motor B Run
		OFF	Blinks (6Hz)	—	Low voltage / Fuse blown
		OFF	Blinks (1Hz)	—	Motor B unplugged
		ON	Blinks (1Hz)	—	Motor stall error
		OFF	ON	—	thermister error
		ON	Blinks (6Hz×2⇔1.7sec)	—	back EMF error

\* Power is not supplied to motor drive circuit board. The HBM may be needed replace.

9. Maintenance/Inspection

Error status and reset error

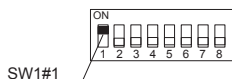

- SW1#1 allows the selection of the error signal discharge timing : discharge on normal status or discharge when error arises. (Effective only when power is turned on .)

**!**

- When error signals have been released by CN2#1 (RUN / STOP), the F-RAT instantly starts up when RUN is input.
- When the power supply voltage becomes insufficient, operation may be disabled, or an unexpected operation may occur.
- To restart the F-RAT, switch the ON → OFF → ON / OFF → ON → OFF / RUN → STOP → RUN signals at intervals of 100 ms or more.

■ Error status and reset error

Error type		Symptom / Causes		Reset driver card / MDR	
Error related power	Low voltage error	Low voltage below 15 V DC for 1 second	Supply 18 V DC or over	Auto reset	Restarts immediately when error condition is removed.
	Back EMF error	Supply voltage more than 40 V DC for 2 second or over 60 V DC for 0.1 second	Supply 30 V DC or below	Manual reset	After securing the power supply voltage, error signal is reset and start up the unit by CN#1 ON → OFF → ON or CN2#2 ON → OFF → ON / OFF → ON → OFF. ※
				Auto reset	n.a
Fuse blown	Replace the driver card				
Error related temperature	Thermal overload	<ul style="list-style-type: none"> <li>• Thermister on PCB reacted</li> <li>• Thermister in motor reacted</li> </ul>	<ul style="list-style-type: none"> <li>• Thermister recovery from cooling off.</li> <li>• Thermister recovery from cooling off.</li> </ul>	Auto reset	Thermister recovery from cooling off.
				Manual reset	After securing the power supply voltage, error signal is reset and start up the unit by CN#1 ON → OFF → ON or CN2#2 ON → OFF → ON / OFF → ON → OFF. ※
Other error	Motor unplugged error	Motor connector unplugged	Plug the motor connector	Auto reset	Restarts immediately when error condition is removed.
	Motor lock error	Motor stall for 0.5 second	Motor is turned.	Manual reset	After securing the power supply voltage, error signal is reset and start up the unit by CN#1 ON → OFF → ON or CN2#2 ON → OFF → ON / OFF → ON → OFF. ※
				Auto reset	Driver detect motor is turned. (More than 8 pluses)
Manual reset	After securing the power supply voltage, error signal is reset and start up the unit by CN#1 ON → OFF → ON or CN2#2 ON → OFF → ON / OFF → ON → OFF. ※				

※ By changing signal at CN2#2, only the error signal is cleared. After releasing the error, MDR will recover and run CN2#1 ON → OFF → ON.

Safety precautions

Advance preparation

Product check

Structures

Installation/Wiring

Control/Operation

Maintenance/Inspection

Troubleshooting





Appendix

9. Maintenance/Inspection

[CB-016]

For roller transfer

LED display explanation











 : ON    
  : Blinking (1Hz)    
  : Blinking (6Hz)    
  : OFF

Errors can be checked by PWR (Green), ERR (Red), and signals from CN2#4.

- 
 ■ When error signals have been released by CN2#1 (RUN / STOP), the F-RAT instantly starts up when RUN is input.
- When the power supply voltage becomes insufficient, operation may be disabled, or an unexpected operation may occur.
- To restart the F-RAT, switch the ON → OFF → ON / OFF → ON → OFF / RUN → STOP → RUN signals at intervals of 100 ms or more.

Error details

(M) : Manual recovery setting (SW1#1 ON) / (A) : Automatic recovery setting (SW1#1 OFF <factory setting>)

PWR (Green) ERR (Red)	CN2#4 (Error signal)		Causes	How to release error signals	Recovery operation
	SW1#4 OFF	SW1#4 ON			
	Output	Open	(Normal operation)	—	
	Open	Open	No power supply	Supply 24V DC	Refer to P.35 7-3. Wiring
	Open	Output	Damage to driver cards	Turn off the power, and replace the driver card	Refer to P.33, 35 7-2. Installation 7-3. Wiring
 	Open	Output	Thermal error Thermal protection has worked due to a temperature rise of driver cards or MDR	(A) When one minute has elapsed after decreasing to the recovery temperature, the error signal is released, and the unit starts up instantly After decreasing to the recovery temperature, release the error signal, and start up the unit by RUN→STOP→RUN on CN2#1 After decreasing to the recovery temperature, switch ON→OFF→ON or OFF→ON→OFF on CN2#2 Start up the unit by RUN→STOP→RUN on CN2#1 The unit starts up within 1min (M) After decreasing to the recovery temperature, release the error signal, and start up the unit RUN→STOP→RUN on CN2#1 After decreasing to the recovery temperature, switch ON→OFF→ON or OFF→ON→OFF on CN2#2 Start up the unit by RUN→STOP→RUN on CN2#1	
 	Open	Output	Connector disconnected	Turn off the power, and connect the connector	Refer to P.35 7-3. Wiring
 	Open	Output	MDR disconnection	Turn off the power, and replace the MDR	Refer to P.58 9-2. Before replacement work
	Open	Output	Lock error MDR has been locked, and 4sec have elapsed	Release the error signal, and start up the unit by RUN→STOP→RUN on CN2#1 Switch ON→OFF→ON or OFF→ON→OFF on CN2#2	Start up the unit by RUN→STOP→RUN on CN2#1
	Open	Output	Low voltage error Power supply voltage is 15 V or less	(A) Secure the power supply voltage of 18V or more After securing the power supply voltage of 18V or more, release the error signal, and start up the unit by RUN→STOP→RUN on CN2#1 (M) After securing the power supply voltage of 18V or more, switch ON→OFF→ON or OFF→ON→OFF on CN2#2	The unit starts up instantly Start up the unit by RUN→STOP→RUN on CN2#1

Errors will be also released when the power is OFF (for two seconds or more).

Safety precautions

Advance preparation

Product check

Structures

Installation/Wiring

Control/Operation

Maintenance/Inspection

Troubleshooting

Appendix

9. Maintenance/Inspection

[HBM-201]  
For switching the transfer surface

Even if inputting the signal to CN2#4 and #5, but the signal output from CN2#1 and #2 does not change, the following errors have been assumed to occur. Errors can be distinguished by the LED display.

LED display explanation

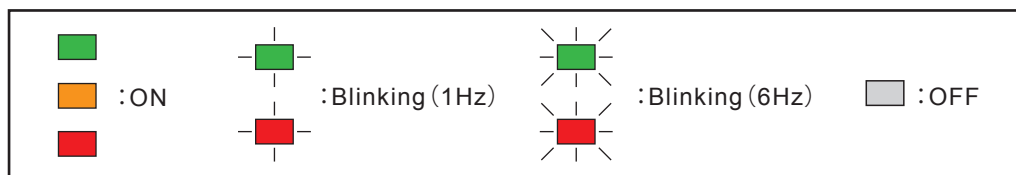

Error details

PWR (green)	ERR (Red)	Description	Causes	Recovery conditions	Recovery operation
		Stop (signals not input)			
3Hz blinking × 2 ⇕ OFF for 480ms		When wheel surface transfer is effected (Signal is being input to CN2#5)	(Normal operation)		-
3Hz blinking × 3 ⇕ OFF for 480ms		When roller surface transfer is effected (Signal is being input to CN2#4)			
		During teaching operation (Signal is being input to CN2#4 and CN2#5)			
		No teaching setting	Teaching setting incomplete	Teaching setting complete	Refer to P.50 8-5. About the initial position setting (teaching) of the transfer surface
*		Thermal error	Driver card temperature is 85°C or more, or MDR temperature is 110°C or more	Driver card temperature is 75°C or less, and MDR temperature is 95°C or less	Take one of among the following measures: ■ Turn CN2#4 (INPUT1) OFF and ON ■ Turn CN2#5 (INPUT2) OFF and ON ■ Turn CN2#4 (INPUT1) and CN2#5 (INPUT2) OFF and ON
*		MDR disconnected	MDR connectors removed	Connect the MDR connectors	
*		Lock error	MDR has been locked when switching the transfer surface	Eliminate the cause of lock	
		Low voltage error	The voltage has been 17 V or less for 1sec, or the power connector is connected improperly	Supply a voltage of 24V DC ± 10%, or properly connect the power connector again	
		Fuse blown	Driver card fuse blown	Replace the driver card	Refer to P.33, 35 7-2. Installation 7-3. Wiring

\* Indicates the signal input status during normal operation.

STATUS (Orange) details

STATUS (Orange)	Description
	No teaching setting / During teaching operation / When the transfer surface is being switched
	Roller surface standby / Carrier wheel surface standby

9. Maintenance/Inspection

9-2. Before replacement work

If any abnormalities, such as damaged parts, are found, immediately take actions, including replacement with new parts.

- Check the model of this product, and prepare parts to be replaced with in advance.
- Contact us for repair/replacement of parts other than those mentioned below.

Product label

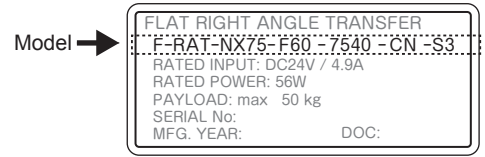

Replacement parts list

Carrier wheel cassette

Part number : NX75-CC□□○-HD1

□□ : 60 / 75 / 90      ○ : A / B / C / D / E

Indicates size (L direction) for the model of this product.      Indicates type of the cassette.

Example) F-RAT-NX75-F60-7550-CN-S3

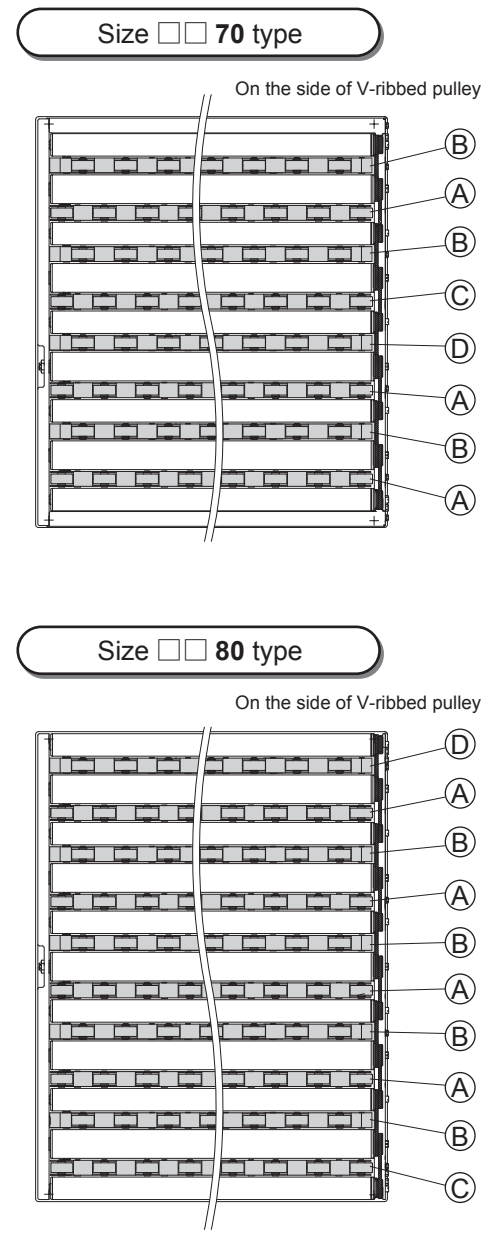
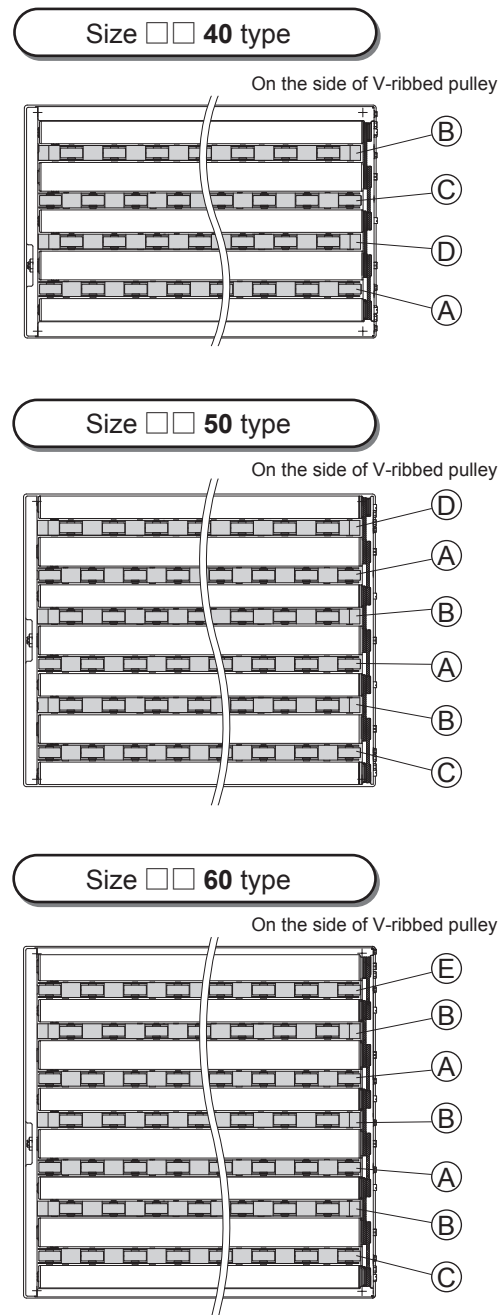

Example) Carrier wheel cassette Type ② for F-RAT-NX75-F60-7550-CN-S3 : NX75-CC-75②-HD1

Safety precautions  
Advance preparation  
Product check  
Structures  
Installation/Wiring  
Control/Operation  
Maintenance/Inspection  
Troubleshooting  
Appendix

**9. Maintenance/Inspection**

Roller drive belt  
(V-ribbed belt)

Part number : 2PJ-265

The part number of which only belts, size □□60 \*1 type, are used to link Φ38 idlers, is 2PJ-246.

\* 1 Indicates size (W direction) for the model of this product  
Example) F-RAT-NX75-F60-7560-CN-S3

Roller transfer MDR

Size 60 *1 □□	PM486FE-(17/60)*2 -542-D-024-JA-Z150-VN
Size 75 *1 □□	PM486FE-(17/60)*2 -692-D-024-JA-Z150-VN
Size 90 *1 □□	PM486FE-(17/60)*2 -842-D-024-JA-Z150-VN

\* 1 Indicates size (L direction) for the model of this product  
Example) F-RAT-NX75-F60-7550-CN-S3  
\* 2 Indicates the nominal speed for the model of this product  
Example) F-RAT-NX75-F60-7550-CN-S3

Idler

Size 60 *1 □□	φ 38	ARI-38-542-JC-VN
	φ 48.6	ARI-48-542-JB-VN
Size 75 *1 □□	φ 38	ARI-38-692-JC-VN
	φ 48.6	ARI-48-692-JB-VN
Size 90 *1 □□	φ 38	ARI-38-842-JC-VN
	φ 48.6	ARI-48-842-JB-VN

\* 1 Indicates size (L direction) for the model of this product  
Example) F-RAT-NX75-F60-7550-CN-S3

Driver card

Standard type 

	Driver cards
M1 : For carrier wheel transfer	CBK-109F□
M2 : For roller transfer	CB-016B□6
M3 : For drive switching	HBM-201B□

\* Specify □ = N (NPN signal input/output) / P (PNP signal input/output).

E1 type 

	Driver cards
M1, M4 : For carrier wheel transfer	HBK-608F□-CP3
M2 : For roller transfer	CB-016B□6
M3 : For drive switching	HBM-201B□

\* Specify □ = N (NPN signal input/output) / P (PNP signal input/output).

Safety precautions

Advance preparation

Product check

Structures

Installation/Wiring

Control/Operation

Maintenance/Inspection

Troubleshooting

Appendix

## 9. Maintenance/Inspection

### 9-3. Replacement of roller transfer MDR/idlers/roller drive belts

#### Before replacement

If any abnormalities are found in one of the roller transfer MDR, idlers, and/or roller drive belts, replace them according to the following methods.

- 1 Before replacement, prepare necessary tools.

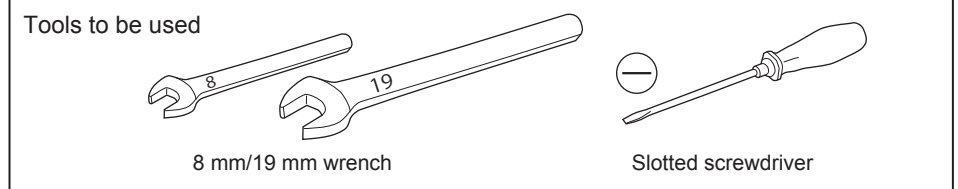

- 2 Turn off the power of all connecting devices.



- Shut off the power switch, leave for three minutes or more, and discharge electricity inside the DC power supply equipment.
- Wear protective equipment, such as gloves.

#### Replacement procedures

### Removing roller transfer MDR/idlers/roller drive belts

#### Remove the hold cover

- 1 Remove the screws at the four positions, and remove the hold cover from the F-RAT main unit.

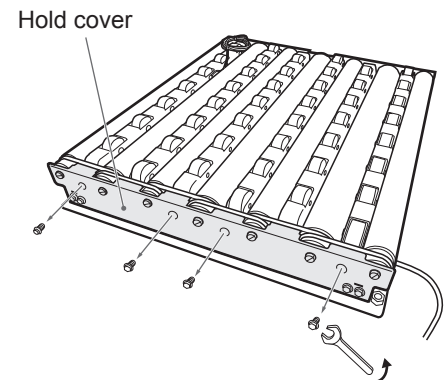

#### Remove idlers

Remove idlers in order, from the edge of the module, to the position where the roller transfer MDR, idler, or roller drive belt to be replaced can be removed.

- 1 Push deeper the spring loaded shaft of the idler using the tip of a slotted screwdriver, etc.

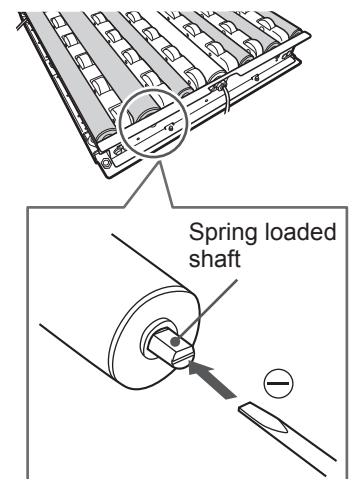

9. Maintenance/Inspection

Replacement procedures

- Slide the spring loaded shaft from the fixed hole (1), and remove the idler from the frame (2)

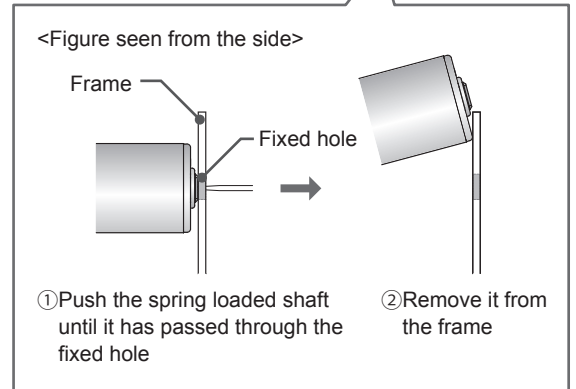
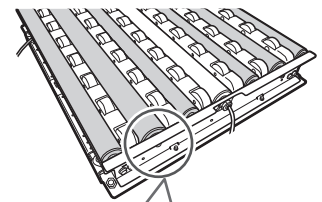

- Remove the roller drive belt, and remove the idler



■ The roller drive belt can be removed easily by pulling it while turning the idler.

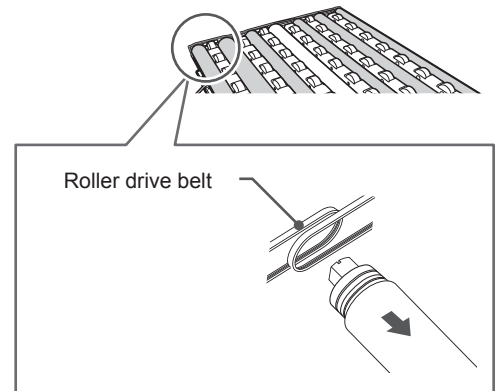

Remove other idlers in the same procedures.

Remove the roller transfer MDR

- Remove the cable tie securing the power cable (1), and remove the hex.nut M12 / toothed washer from the power cable (2)



■ When removing the hex.nut M12 / toothed washer, be careful not to damage the cable.

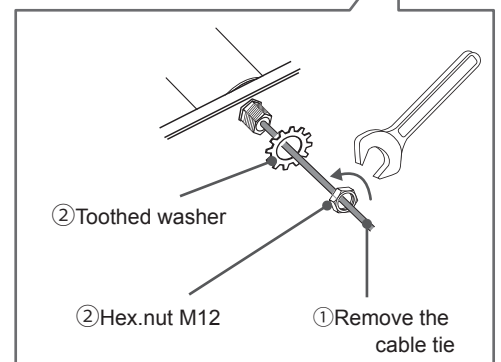
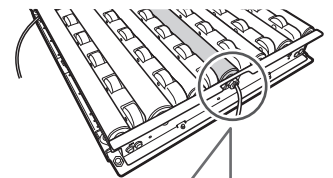

## 9. Maintenance/Inspection

### Replacement procedures

- 2 Lift up the tip of the roller transfer MDR (①), and remove the roller drive belt. (②) Remove the roller transfer MDR (③), and pull the power cable off the fixed hole on the frame (④)

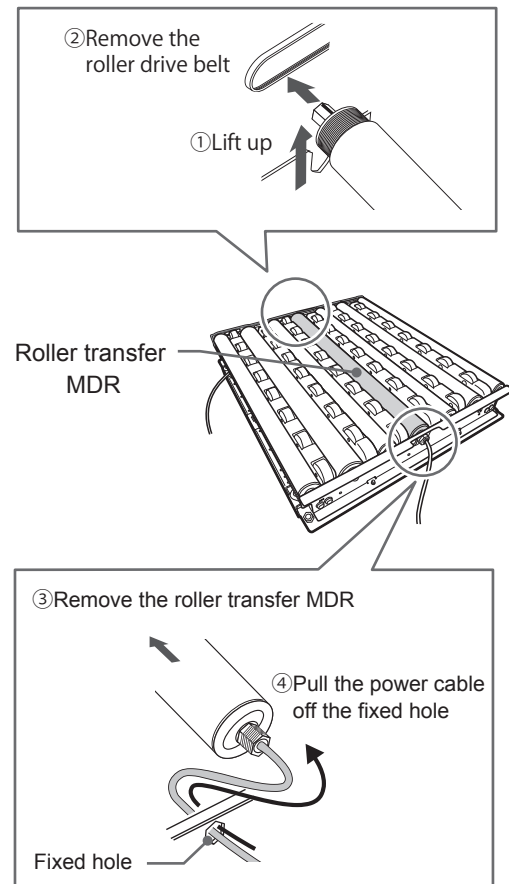

## Mounting roller transfer MDR/idlers/roller drive belts

### Mount the roller transfer MDR

- 1 Pass the roller transfer MDR power cable through the fixed hole on the frame (①), and put the attaching shaft into the hole (②)

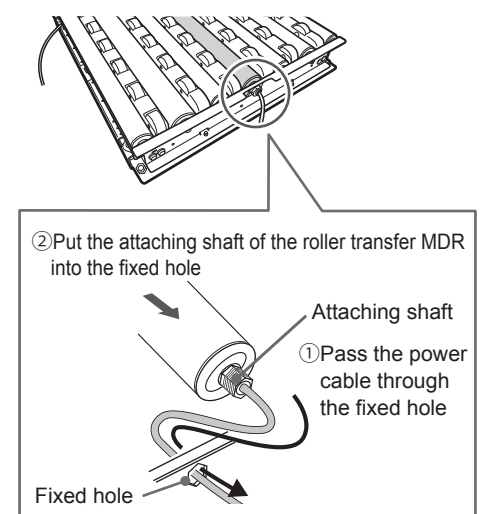

9. Maintenance/Inspection

Replacement procedures

- Mount the roller drive belt on the V-ribbed pulley of the roller transfer MDR (1), align the tip of the attaching shaft with the notch shape, and fit it into the frame (2)

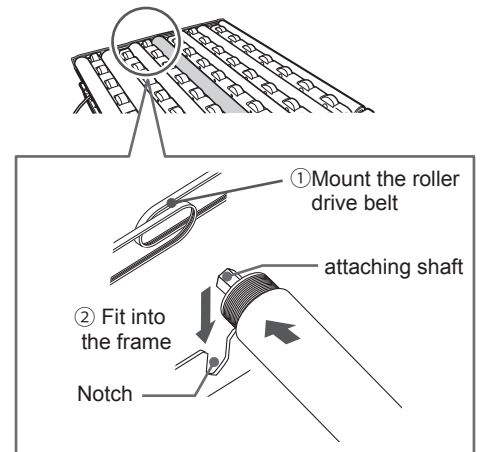
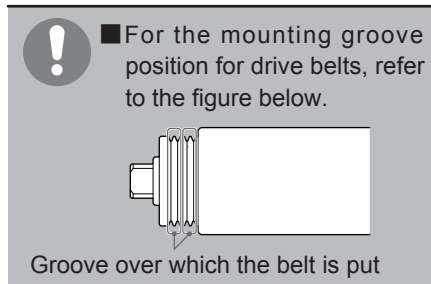

- Fix the hex.nut M12 / toothed washer (1), and bind the power cable with the cable tie (2)

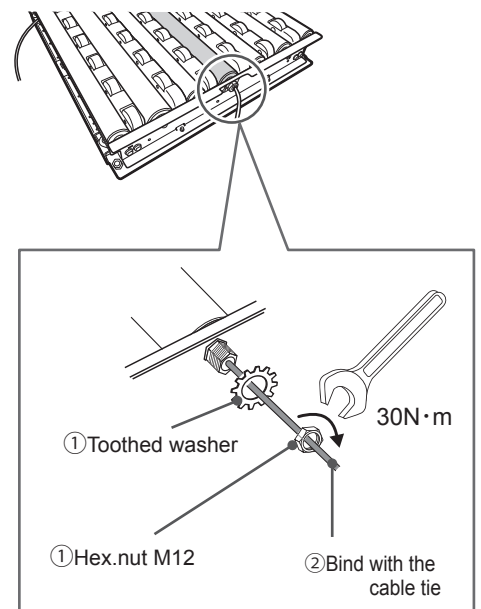
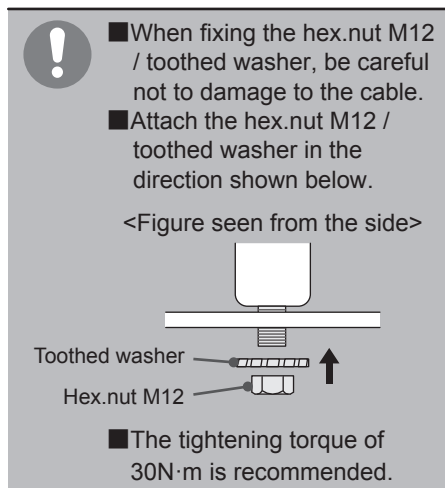

Mount the idler

- Mount the roller drive belt on the V-ribbed pulley on the idler

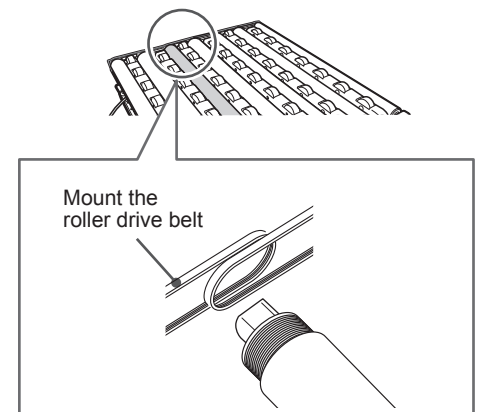
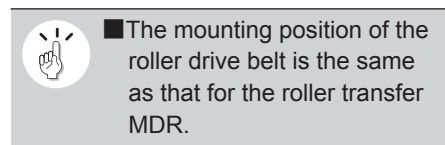

**9. Maintenance/Inspection**

Replacement procedures

- Align the tip of the attaching shaft on the side of the belt on the V-ribbed pulley, where the roller drive belt has been mounted, with the notch shape on the frame, and fit it into the frame

**!** Press the D-shaped cut surface of the axis onto the plate, and fit it into the frame.

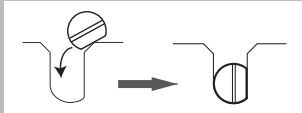

**!** Check that the attaching shaft has come out of the external side of the frame, as shown in the figure below.

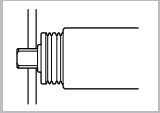
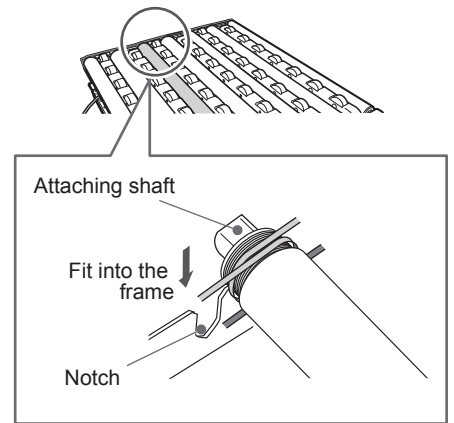
- Push the spring loaded shaft of the idler by the tip of a slotted screwdriver, etc. (1), and pass it through the fixed hole (2)

**!** Check that the spring loaded shaft has sufficiently come out of the external side of the frame, as shown in the figure below.

**Mount the hold cover**

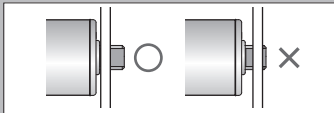
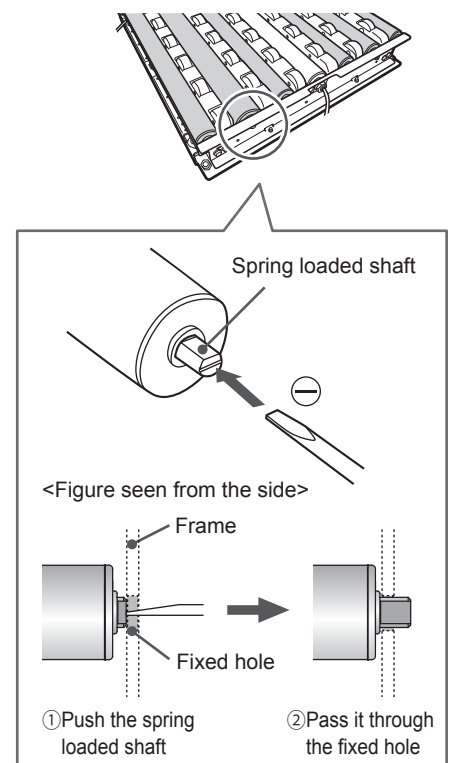
- Mount the hold cover in the reverse of the procedures on page 60, "Remove the hold cover".

**!** Make sure to mount the hold cover so that the roller drive belt can be seen.

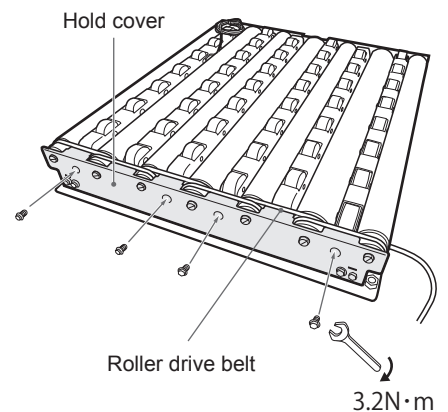

Safety precautions

Advance preparation

Product check

Structures

Installation/Wiring

Control/Operation

Maintenance/Inspection

Troubleshooting

Appendix

**9. Maintenance/Inspection**

**9-4. Replacement of the carrier wheel cassette**

Before replacement

If any abnormalities are found in the carrier wheels, replace the whole carrier wheel cassette.

**1** Before replacement, prepare necessary tools.

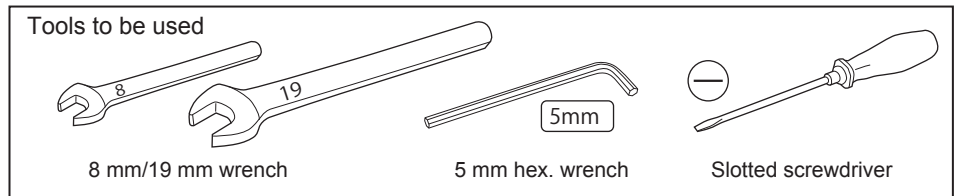

**2** Turn off the power of all connecting devices.

- Shut off the power switch, leave for three minutes or more, and discharge electricity inside the DC power supply equipment.
- Wear protective equipment, such as gloves.

Replacement procedure

**Removing roller transfer MDR/idlers/roller drive belts**

Remove the idlers in order, from the edge of the module to the position where the carrier wheel cassette to be replaced can be removed.



**9-3. Replacement of roller transfer MDR/idlers/roller drive belts**

**Removing roller transfer MDR/idlers/roller drive belts**

**Remove the carrier wheel cassette**

**1** Remove hex. bolts at four positions circled on the carrier wheel cassette to be replaced, and lift up the cassette.

- When removing hex. bolts, be careful not to drop them and/or the hex. wrench on the lower part of the F-RAT.

Example) For size 7550

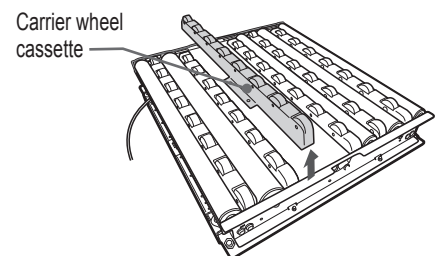
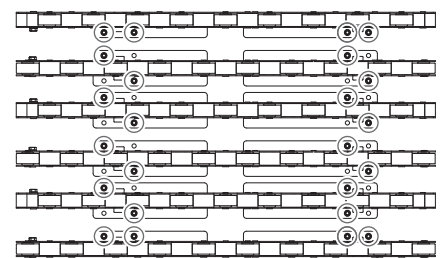

9. Maintenance/Inspection

Replacement procedures

**Mounting the carrier wheel cassette on the F-RAT main unit**

- 1 Check the model of the removed carrier wheel cassette and replacement carrier wheel cassette.



Indication example)

NX-75CC-75A-HD1

This part of the carrier wheel cassette is indicated on the product.

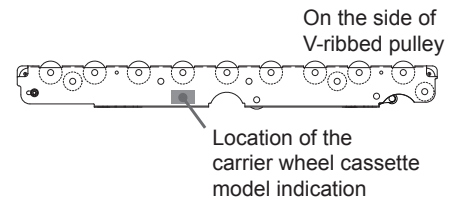

- 2 Mount the replacement carrier wheel cassette with hex. bolts at four positions circled in the figure, and secure it.



The tightening torque of 11 N·m is recommended. Excessive tightening may result in damage to hex. bolts.

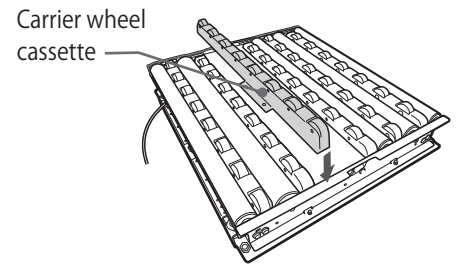
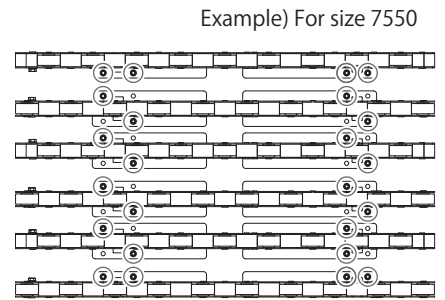

**Mounting roller transfer MDR/idlers/roller drive belts**

Mount the roller transfer MDR, idlers, and/or roller drive belt that have been removed.



9-3.

Replacement of roller transfer MDR/idlers/roller drive belts

**Mounting roller transfer MDR/idlers/roller drive belts**

# 10. Troubleshooting

## 10. Troubleshooting

If you believe the product may be malfunctioning, check the contents described in this section before contacting the supplier and/or asking for repair.

### Symptoms

F-RAT does not operate

Items to be checked	Countermeasures	References
Is PWR LED (Green) for each driver card ON? Or, has 24 VDC been supplied in the power connector part of driver cards?	Supply 24V DC.	7. Installation/ Wiring (⇒P.25)
Is ERR LED (Red) for each driver card blinking, or is it ON and is there an error output?	Remove the cause of error, and release the error.	9. Maintenance/ inspection (⇒P.60)
Has each connector been connected correctly? Has wiring been performed properly?	Check wiring, and perform wiring properly if it has not already been done so.	7. Installation/ Wiring (⇒P.25)
Has each driver card type* (NPN input/output / PNP input/output) matched the input and output signals (NPN input/output / PNP input/output) on PLCs? *Check the model of driver cards.	Match each driver card type (NPN input/output / PNP input/output) with the input and output signals on PLCs (NPN input/output / PNP input/output).	7. Installation/ Wiring (⇒P.25)
Is 0V of control power common with 0V of Power Supply ?	Ensure that 0V of the control power is common with the 0V of motor Power Supply.	7. Installation/ Wiring (⇒P.25)

The transfer surface cannot be switched, or transfer surface switching operation is incorrect

Items to be checked	Countermeasures	References
Has the initial setting (teaching setting) been performed?	Perform the initial setting (teaching setting).	Initial setting (Teaching setting) (⇒P.56)
Is ERR LED (Red) on the driver card for M3: drive switching blinking, or is it ON and is there an error output?	Remove the cause of error, and release the error.	9. Maintenance/ inspection (⇒P.60)
Has the RUN signal input to the driver card for M3: drive switching corresponded to the transfer surface? Also, is the input timing correct?	Check the signal input and input timing when the transfer surface is switched.	8. Control/ Operation (⇒P.45)
Has the setting of the driver card for M3: drive switching not been changed?	Check the setting of the driver card for M3: drive switching switch.	8. Control/ Operation (⇒P.45)

## 10. Troubleshooting

### Symptoms

When loading,  
trays get stuck, or  
cannot be transferred

Items to be checked	Countermeasures	References
Is the load conveyor level the same as the level of the F-RAT?	Align levels of the load conveyor and the F-RAT.	7. Installation/ Wiring (⇒P.25)
When loading by carrier wheels, have they been set on the top of the surface? When loading by rollers, have they been set on the top of the surface?	Set either carrier wheels or rollers on the top of the surface according to the loading direction.	8. Control/ Operation (⇒P.45)
When loading by carrier wheels, have you run the carrier wheel MDR (M1* <sup>1</sup> )? When loading by rollers, have you run the roller MDR (M2)? Also, have you run the MDR until loading ends?	Run either carrier wheel MDR (M1* <sup>1</sup> ) or roller MDR (M2) according to the loading direction until transfer ends.	8. Control/ Operation (⇒P.45)
When loading by carrier wheels, are there any carrier wheels rotating slower than others?	Replace the carrier wheel cassette including the slow rotating wheels.	9. Maintenance/ inspection (⇒P.60)
Has the transfer drive switching MDR (M3) not run at the time of loading?	Do not run the drive switching MDR (M3) until transfer ends.	8. Control/ Operation (⇒P.45)

When discharging,  
trays get stuck, or  
cannot be transferred

Items to be checked	Countermeasures	References
Is the discharge conveyor level same as the level of the F-RAT?	Align levels of the discharge conveyor and the F-RAT.	7. Installation/ Wiring (⇒P.25)
When discharging by carrier wheels, have they been set on the top of the surface? When discharging by rollers, have they been set on the top of the surface?	Set either carrier wheels or rollers on the top of the surface according to the discharging direction.	8. Control/ Operation (⇒P.45)
When discharging by carrier wheels, have you run the carrier wheel MDR (M1)? When discharging by rollers, have you run the roller MDR (M2)? Also, have you run the MDR until discharging ends?	Run either carrier wheel MDR (M1) or roller MDR (M2) according to the discharging direction until discharging ends.	8. Control/ Operation (⇒P.45)
When discharging by carrier wheels, are there any carrier wheels rotating slower than others?	Replace the carrier wheel cassette including the slow rotating wheels.	9. Maintenance/ inspection (⇒P.60)
Has the transfer drive switching MDR (M3) not run at the time of discharging?	Do not run the drive switching MDR (M3) until discharging ends.	8. Control/ Operation (⇒P.45)

\* M1 and M4 are applicable for E1 type.

## 10. Troubleshooting

### Symptoms

- The speed cannot be changed
- The speed setting is incorrect

Items to be checked	Countermeasures	References
To change the carrier wheel speed, have you operated the switch on the driver card for M1* <sup>1</sup> : carrier wheels [CBK-109* <sup>2</sup> ]? To change the roller speed, have you operated the switch on the driver card for M2: rollers [CB-016]?	To change the carrier wheel speed, operate the switch on the driver card for M1* <sup>1</sup> : carrier wheels [CBK-109* <sup>2</sup> ]. To change the roller speed, operate the switch on the driver card for M2: rollers [CB-016].	Changing the transfer speed (⇒P.52)
Have you changed the speed externally by the voltage input to CN2#3 on CBK-109/CB-016?	Check the external speed settings, and input proper voltage to match the set speed.	Changing the transfer speed (⇒P.52)
When changing the speed by the external voltage, is the power supply 0 V of the external voltage common to 0 V on the driver card?	Use the common power supply 0V.	7. Installation/ Wiring (⇒P.25)

The transfer direction (rotating direction of carrier wheels/rollers) is incorrect

Items to be checked	Countermeasures	References
Is the transfer/diverting direction based on the rotating direction settings for the driver card for M1* <sup>1</sup> : carrier wheels/M2: rollers?	Set the correct transfer/diverting direction, and the correct the rotating direction for the driver card for M1* <sup>1</sup> : carrier wheels/M2: rollers.	8. Control/ Operation (⇒P.45)

\* M1 and M4 are applicable for E1 type.

\*2 HBK-608-CP3 is applicable for E1 type.

# Appendix

Appendix

Appendix 1.  
Product specifications

F-RAT main unit specifications

Size 60 □ □

		6040	6050	6060	6070	6080
F-RAT main unit	Total length (L) Carrier wheel transfer direction	595mm				
	Total width (W) Roller transfer direction	395mm	495mm	595mm	695mm	795mm
	Weight	32kg	38kg	44kg	52kg	60kg
Maximum load weight		50kg				

Size 75 □ □

		7540	7550	7560	7570	7580
F-RAT main unit	Total length (L) Carrier wheel transfer direction	745mm				
	Total width (W) Roller transfer direction	395mm	495mm	595mm	695mm	795mm
	Weight	42kg	48kg	54kg	63kg	71kg
Maximum load weight		50kg				

Size 90 □ □

		9040	9050	9060	9070	9080
F-RAT main unit	Total length (L) Carrier wheel transfer direction	895mm				
	Total width (W) Roller transfer direction	395mm	495mm	595mm	695mm	795mm
	Weight	52kg	58kg	64kg	74kg	82kg
Maximum load weight		50kg				

\* Values of the maximum load weight are reference only since they may change depending on tray conditions.  
Depending on the bottom shape of trays, they may not be transferred normally, even if they are within the above size range.

Common

Material	Frame	Galvanized iron
	Carrier wheel	Urethane
	Roller	STKM
Speed ※	Carrier wheel	7.7 ~ 66.7m/min
	Roller	2.1 ~ 18.3m/min (PM486FE-17 type)
		7.5 ~ 65.0m/min (PM486FE-60 type)
Transfer surface switching time		0.6s

※Values indicate the speed when trays are not placed on carrier wheels and rollers.



- During operation, the rising time to the setting speed may vary depending on ambient temperature. Perform running operation thoroughly.
- Values described above may differ from the actual transfer speed depending on the weight, material, bottom surface, and/or shape of trays, as well as ambient temperature.

Operating environment	Ambient temperature	0 to 40°C (no freezing)
	Ambient humidity	90%RH or less (no condensation)
	Altitude	1,000 m or less
	Atmosphere	No corrosive gas
	Vibration	0.5G or less
	Location	Indoor
	Pollution degree	2 (according to the definition of IEC60664-1, UL840)

Product label

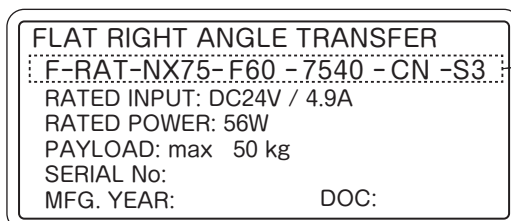

Product model

Safety precautions

Advance preparation

Product check

Structures

Installation/Wiring

Control/Operation

Maintenance/Inspection

Troubleshooting

Appendix

## Appendix

Appendix 1.  
Product specifications

## Driver card specifications

Standard type 

		For carrier wheel transfer	For roller transfer	For drive switching
Model		<b>CBK-109F</b> □ (□=N : NPN, P : PNP)	<b>CB-016B</b> □ <b>6</b> (□=N : NPN, P : PNP)	<b>HBM-201B</b> □ (□=N : NPN, P : PNP)
Power supply voltage		24V DC±10%		
Rated voltage		24V DC		
Static current		0.06A	0.03A	0.06A
Starting current		7.0A	4.0A	3.7A to 4.4A
Peak current		30A (1msec or less)	20A (1msec or less)	20A (1msec or less)
Wire diameter (Applicable wires to connectors included as standard)	Power connector (CN1)	0.80 to 1.5mm <sup>2</sup> (AWG : 18 to 14)	0.50 to 1.5mm <sup>2</sup> (AWG : 20 to 14)	0.50 to 1.5mm <sup>2</sup> (AWG : 20 to 14)
	Control connector (CN2)	0.08 to 0.5mm <sup>2</sup> (AWG : 28 to 20)		
Thermal protection		Driver card: 95°C Motor: 105°C	Driver card: 95°C Motor: 105°C	Driver card: 85°C Motor: 110°C
Operating environment	Ambient temperature	0 to 40°C (no freezing)		
	Ambient humidity	90%RH or less (no condensation)		
	Atmosphere	No corrosive gas		
	Vibration	0.5G or less		
	Location	Indoor		
Time from RUN signal input to motor starting		15 msec or less	15 msec or less	—

E1 type 

		For carrier wheel transfer	For roller transfer	For drive switching
Model		<b>HBK-608F</b> □- <b>CP3</b> (□=N : NPN, P : PNP)	<b>CB-016B</b> □ <b>6</b> (□=N : NPN, P : PNP)	<b>HBM-201B</b> □ (□=N : NPN, P : PNP)
Power supply voltage		24V DC±10%		
Rated voltage		24V DC		
Static current		0.06A	0.03A	0.06A
Starting current		7.0A×2 motors	4.0A	3.7A to 4.4A
Peak current		40.5A (1msec or less)	20A (1msec or less)	20A (1msec or less)
Wire diameter (Applicable wires to connectors included as standard)	Power connector (CN1)	2.0 ~ 2.5mm <sup>2</sup> (AWG : 14 ~ 12)	0.50 to 1.5mm <sup>2</sup> (AWG : 20 to 14)	0.50 to 1.5mm <sup>2</sup> (AWG : 20 to 14)
	Control connector (CN2)	0.08 to 0.5mm <sup>2</sup> (AWG : 28 to 20)		
Thermal protection		Driver card: 95°C Motor: 105°C	Driver card: 95°C Motor: 105°C	Driver card: 85°C Motor: 110°C
Operating environment	Ambient temperature	0 to 40°C (no freezing)		
	Ambient humidity	90%RH or less (no condensation)		
	Atmosphere	No corrosive gas		
	Vibration	0.5G or less		
	Location	Indoor		
Time from RUN signal input to motor starting		15 msec or less	15 msec or less	—

## Transfer throughput

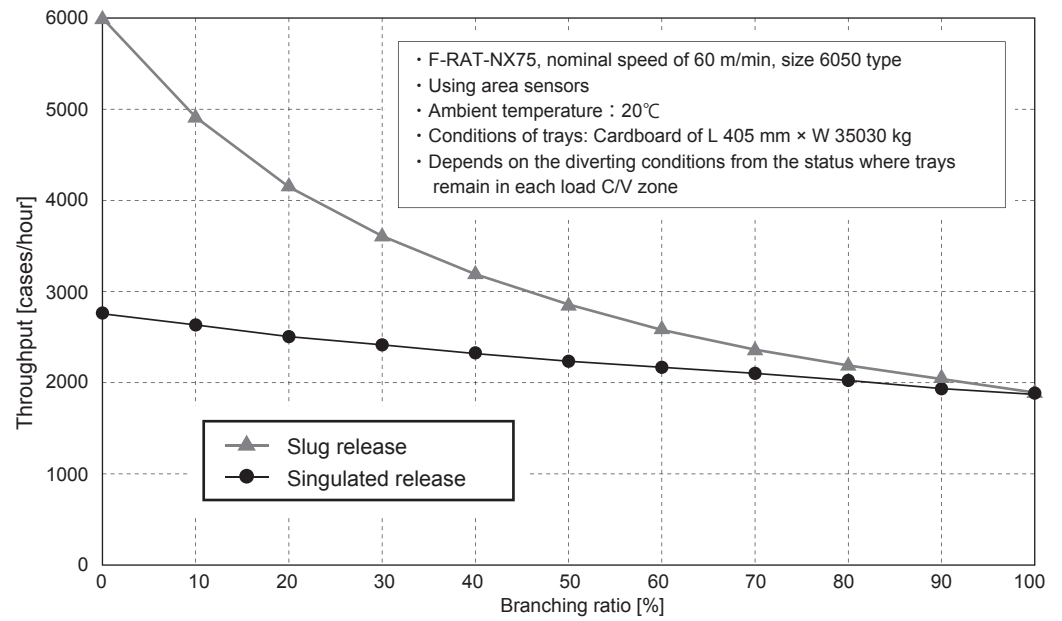

- \* Values on the graph are only references based on our measurement and are not guaranteed.
- \* Slug release data is based on the total control by using idLinX for controlling the conveyors before and after F-RAT.
- \* The stopping distance of trays and throughput depends on the size, material, bottom status of trays, ambient temperature, and/or the speed.

Appendix

Appendix 2.  
Replacement parts/Options

Replacement parts

**!** Do not store carrier wheel cassettes in places subject to high temperature, high humidity, and/or direct sunlight. Failure to follow this could result in its lifetime to be significantly shortened.

Part name		Part number	
1	Carrier wheel cassette	Size 60 * <sup>1</sup> <input type="checkbox"/>	NX75-CC60○-HD1
		Size 75 * <sup>1</sup> <input type="checkbox"/>	NX75-CC75○-HD1
		Size 90 * <sup>1</sup> <input type="checkbox"/>	NX75-CC90○-HD1
		○: Indicates a type of the cassette. For details, refer to P.66	
2	Roller drive belt (V-ribbed pulley)	2PJ-265	
		(2PJ-246) * Only for belts, size <input type="checkbox"/> <input type="checkbox"/> 60 * <sup>2</sup> type, which are used to link Φ38 idlers.	
3	Roller transfer MDR	Size 60 * <sup>1</sup> <input type="checkbox"/>	PM486FE-(17/60)* <sup>3</sup> -542-D-024-JA-Z150-VN
		Size 75 * <sup>1</sup> <input type="checkbox"/>	PM486FE-(17/60)* <sup>3</sup> -692-D-024-JA-Z150-VN
		Size 90 * <sup>1</sup> <input type="checkbox"/>	PM486FE-(17/60)* <sup>3</sup> -842-D-024-JA-Z150-VN
4	Idler	Size 60 * <sup>1</sup> <input type="checkbox"/>	Φ 38 ARI-38-542-JC-VN
			Φ 48.6 ARI-48-542-JB-VN
		Size 75 * <sup>1</sup> <input type="checkbox"/>	Φ 38 ARI-38-692-JC-VN
			Φ 48.6 ARI-48-692-JB-VN
		Size 90 * <sup>1</sup> <input type="checkbox"/>	Φ 38 ARI-38-842-JC-VN
			Φ 48.6 ARI-48-842-JB-VN
5	Driver card <input type="checkbox"/> : Specify the N=NPN/P=PNP type based on the input and output type.	CBK-109F <input type="checkbox"/> (for carrier wheel transfer MDR) * <sup>4</sup>	
		CB-016B <input type="checkbox"/> 6 (for roller transfer MDR)	
		HBM-201B <input type="checkbox"/> (for drive switching MDR)	

- \* 1 Indicates size (L direction) for the model of this product. ----- Example) F-RAT-NX75-F60-7550-CN-S3
- \* 2 Indicates size (W direction) for the model of this product. ----- Example) F-RAT-NX75-F60-7560-CN-S3
- \* 3 Indicates the nominal speed for the model of this product. ----- Example) F-RAT-NX75-F60-7550-CN-S3
- \* 4 HBK-608-CP3 is applicable for E1 type.

Options

Extension cable

**■ CBK-109\* : 12P extension cable length**

Model	12P extension cable length
ACE-CBM-G0600	L= 600mm
ACE-CBM-G1200	L=1200mm

\* HBK-608-CP3 is applicable for E1 type.

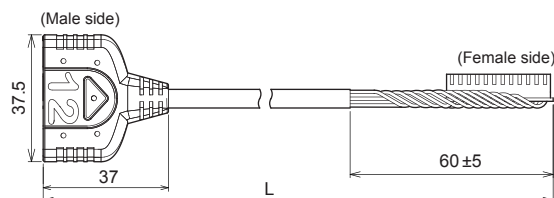

**■ CB-016 / HBM-201 : 10P extension cable length**

Model	10P extension cable length
ACE-CBM-A0600	L= 600mm
ACE-CBM-A0850	L= 850mm
ACE-CBM-A1200	L=1200mm

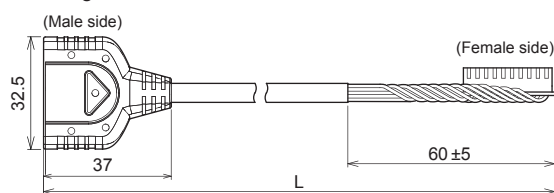

Stay  
(with hex. bolt/plain washer/  
spring washer)

Size	L	X	(mm)
6040 / 7540 / 9040	370	400	
6050 / 7550 / 9050	470	500	
6060 / 7560 / 9060	570	600	
6070 / 7570 / 9070	670	700	
6080 / 7580 / 9080	770	800	

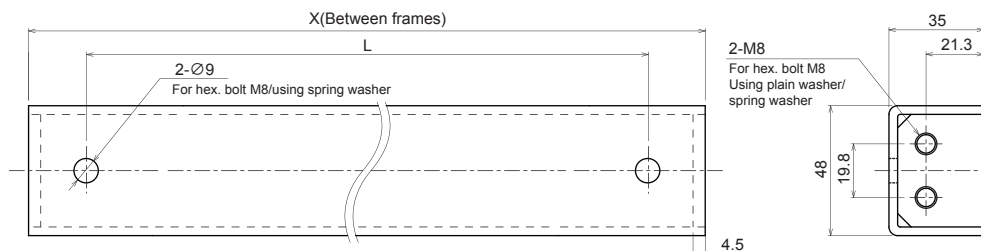

\* For X dimensions (between frames) other than those mentioned above, contact us.

Appendix

**Appendix 3.**  
**Residual risk list/MAP**

**[Seriousness of harm]**

**WARNING:** Indicates that there is a possibility that severe injury or even death may result if protective measures have not been taken

**CAUTION:** Indicates that there is a possibility that minor injury may result if protective measures have not been taken

Residual risk list

No.	Operation stage	Work	Qualifications/ education required for work	Locations on machine	Seriousness of harm	Remaining risk factors	Examples of assumed measures	Measures that have been taken independently	Reference page
1	Installation	Unpack/ Carry	Having carefully read the user manual, and having full knowledge of all the contents	Metal parts on the product	CAUTION	Hands may get injured by metal parts of the product	Wear protective equipment, such as gloves, when working.	Described in the instruction manual	10
2	Installation	Carry		No particular location	CAUTION	Carrying the heavy load alone may result in damage to the main machine unit, and/or injury to the body	Have more than one person hold and support the bottom when carrying.	Described in the instruction manual	10
3	Installation	Carry/ Install		No particular location	CAUTION	Dropping the product or letting it fall when carrying and/or installing may result in damage to the main machine unit, and/or injury to the body	Check safety of installation location in advance, and wear protective equipment, such as protective glasses, footwear, and/or gloves, when working	Described in the instruction manual	10
4	Installation	Install		Bottom of the product	CAUTION	Fingers may get stuck and workers may be injured when securing the main unit on the stay	When putting the main unit on the stay, hold the very bottom of the main unit, and prevent fingers from getting stuck	Described in the instruction manual	36
5	Operation	Trial run		No particular location	CAUTION	At the trial run by the single unit, trays may flow to this product	Stop the surrounding conveyor operation before starting operation	Described in the instruction manual	59
6	Operation	All during operation		Gaps between the moving parts, or moving and fixed parts	WARNING	Workers' fingers and/or hands may get stuck in gaps between the moving parts, or moving and fixed parts of the main unit	Do not touch this product during operation	<ul style="list-style-type: none"> <li>Posting of warning and caution labels</li> <li>Described in the instruction manual</li> </ul>	8
7	Operation	All during operation		Top panel of the product	CAUTION	Workers may step on the main unit and lose their footing, or may fall when the main unit moves	Keep workers informed thoroughly about the prohibition of stepping on the machine	Described in the instruction manual	8
8	Operation	All during operation		No particular location	CAUTION	If problems occur, trays may collide with each other, and pop out of the equipment	For example, mount guide rails on the conveyor frames, and prevent trays from popping.	Described in the instruction manual	11
9	During maintenance/ inspection	All during maintenance/ inspection		Power supply part to the product (driver card)	WARNING	Persons turning on the power without notice may result in unexpected operation of the product, and/or injury of workers	Post warning labels so as to prevent unauthorized persons from turning on the power	Described in the instruction manual	12
10	During maintenance/ inspection	All during maintenance/ inspection		No particular location	WARNING	Workers' fingers and/or hands may get stuck in the product, and injured	<ul style="list-style-type: none"> <li>Wear protective equipment, such as protective glasses, footwear, and/or gloves</li> <li>Do not put hands close to rotating parts.</li> <li>Take off gloves when workers need to get your hands close to rotating parts during operation.</li> </ul>	Described in the instruction manual	13

Residual risk MAP

No.1 CAUTION

No.4 CAUTION

No.6 WARNING

No.7 CAUTION

No.9 WARNING

Residual risk for which location on the machine has not been identified	
No.2  CAUTION	No.8  CAUTION
No.3  CAUTION	No.10  WARNING
No.5  CAUTION	

Safety precautions

Advance preparation

Product check

Structures

Installation/Wiring

Control/Operation

Maintenance/Inspection

Troubleshooting

Appendix

# Technology for tomorrow



---

## ITOHDENKI CO.,LTD.

### Global Headquarters

#### ■ ITOHDENKI CO., LTD.

1146-2 Asazuma-cho, Kasai, Hyogo 679-0105 Japan  
Tel: +81 790 47 0955 Fax: +81 790 47 1325  
[www.itohdenki.co.jp](http://www.itohdenki.co.jp)

### Europe, Middle East, Africa

#### ■ ITOHDENKI EUROPE SAS

490, Avenue des Jourdiés – P.A.E. les Jourdiés  
74800 Saint Pierre en Faucigny, France  
Tel: +33 4 50 03 09 99 Fax: +33 4 50 03 07 60  
[www.itoh-denki.com](http://www.itoh-denki.com)

### North & South Americas

#### ■ ITOHDENKI USA, INC

2 Great Valley Blvd., Wilkes-Barre, PA 18706-5332 U.S.A.  
Tel: +1 570 820 8811 Fax: +1 570 820 8838  
[www.itohdenki.com](http://www.itohdenki.com)

### Mainland China

#### ■ ITOHDENKI SHANGHAI CO., LTD.

Room 1812, No.689, Guangdong Rd., Huangpu district,  
Shanghai 200001, P.R. China  
Tel: +86 21 6341 0181 Fax: +86 21 6341 0180  
[www.itohdenki.com.cn](http://www.itohdenki.com.cn)

---

<https://www.itohdenki.co.jp>

Specifications or appearance of product are subject to change without prior notice.

Ver. 11.0